

LAKEWOOD BUSINESS PARK

FOR LEASE

Building A 10107, Building C 10109, Building D 10111, Building E 10029, Building G 10027, Building H 10025, South Tacoma Way
Lakewood, WA

PREMIER FLEX OFFICE/INDUSTRIAL AND FENCED YARD SPACES ON SOUTH TACOMA WAY



Directly off I-5, Lakewood Business Park is strategically located in the heart of the Pierce County industrial market, with access via South Tacoma Way and 32nd Avenue South.

PROPERTY FEATURES

- Yard space available
- High traffic with frontage to Interstate 5
- 10 miles to Port of Tacoma
- Easy access to Interstate 5 and Highway 512
- Zoned Airport Corridor 1 (AC1)
- Grade level loading

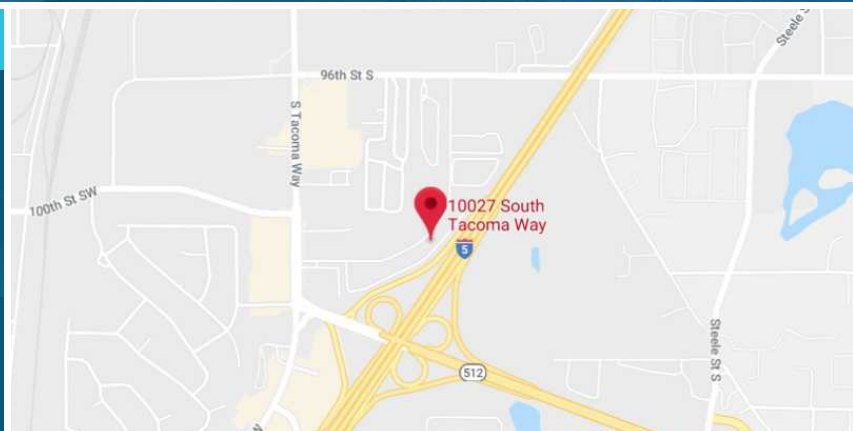

NICK RATZKE, SIOR
253.779.2414
nratzke@neilwalter.com

JOHN DEHAN
253.779.2433
jdehan@neilwalter.com

All information references in this document are approximate. The information contained herein is contained from sources deemed reliable. It is provided without representation, warranty, or guarantee, expressed or implied as to accuracy. Prospective buyer or tenant should conduct its own independent investigation relating to the property, government codes and regulations, allowed uses, and all other matters, regardless of whether they are referred to or contained in this document.

LAKEWOOD BUSINESS PARK

Building A 10107, Building C 10109, Building D 10111, Building E 10029, Building G 10027, Building H 10025, South Tacoma Way
Lakewood, WA



AVAILABLE SUITES

Bldg-Suite	Total SF	Office SF	Loading
D8	7,262 SF	TBD	1 GL
D5	6,136 SF	<1,000 SF	2 GL (Oversized)
C1/C2	5,231 SF	1,500 SF	1 GL
G5/G6	3,114 SF	1,434 SF	2 GL
H8	2,315 SF	701 SF	1 GL
H2	1,946 SF	430 SF	1 GL
D6	815 SF	815 SF	N/A
Yard Lot #2	5,725 SF	N/A	N/A



NICK RATZKE, SIOR
253.779.2414
nratzke@neilwalter.com

JOHN DEHAN
253.779.2433
jdehan@neilwalter.com

All information references in this document are approximate. The information contained herein is contained from sources deemed reliable. It is provided without representation, warranty, or guarantee, expressed or implied as to accuracy. Prospective buyer or tenant should conduct its own independent investigation relating to the property, government codes and regulations, allowed uses, and all other matters, regardless of whether they are referred to or contained in this document.

LAKEWOOD BUSINESS PARK

Building A 10107, Building C 10109, Building D 10111, Building E 10029, Building G 10027, Building H 10025, South Tacoma Way
Lakewood, WA

D8 - 7,262 SF

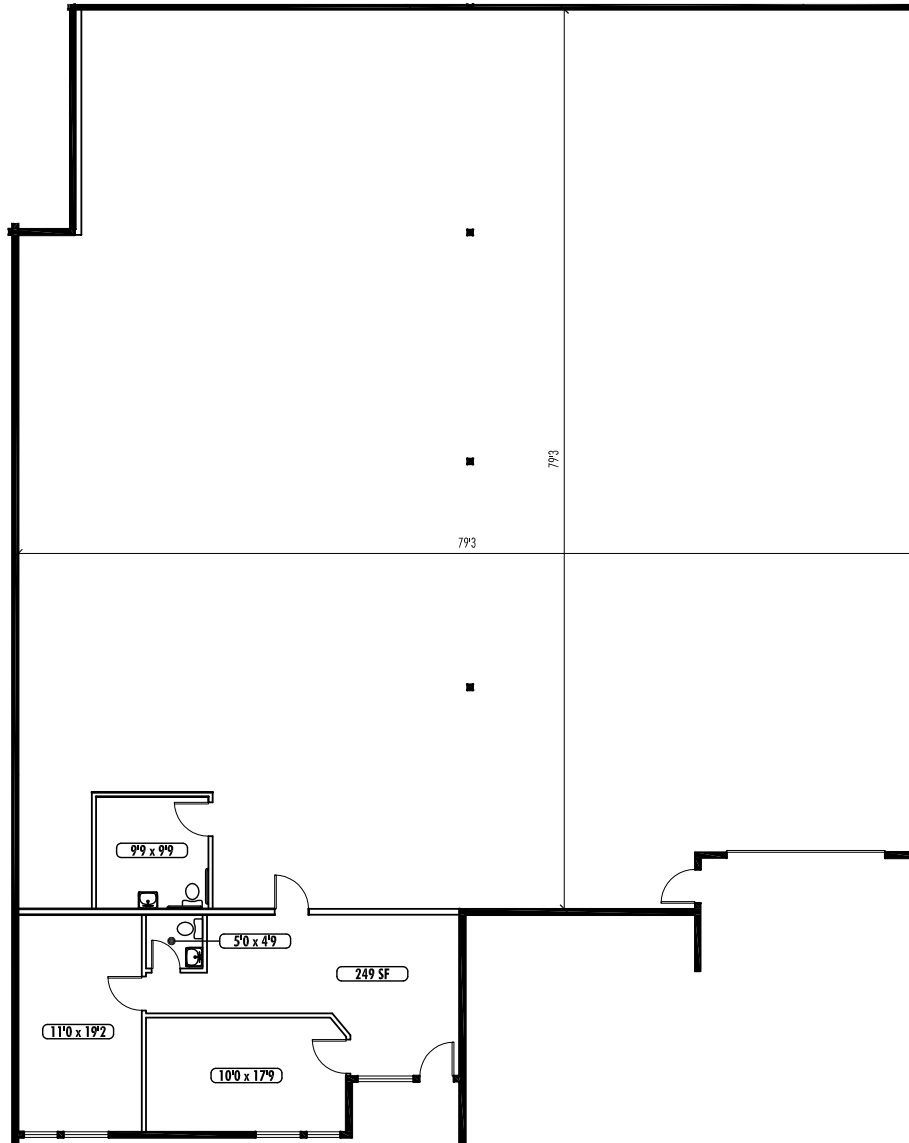

NICK RATZKE, SIOR
253.779.2414
nratzke@neilwalter.com

JOHN DEHAN
253.779.2433
jdehan@neilwalter.com

All information references in this document are approximate. The information contained herein is contained from sources deemed reliable. It is provided without representation, warranty, or guarantee, expressed or implied as to accuracy. Prospective buyer or tenant should conduct its own independent investigation relating to the property, government codes and regulations, allowed uses, and all other matters, regardless of whether they are referred to or contained in this document.

LAKEWOOD BUSINESS PARK

Building A 10107, Building C 10109, Building D 10111, Building E 10029, Building G 10027, Building H 10025, South Tacoma Way
Lakewood, WA

D5 - 6,136 SF

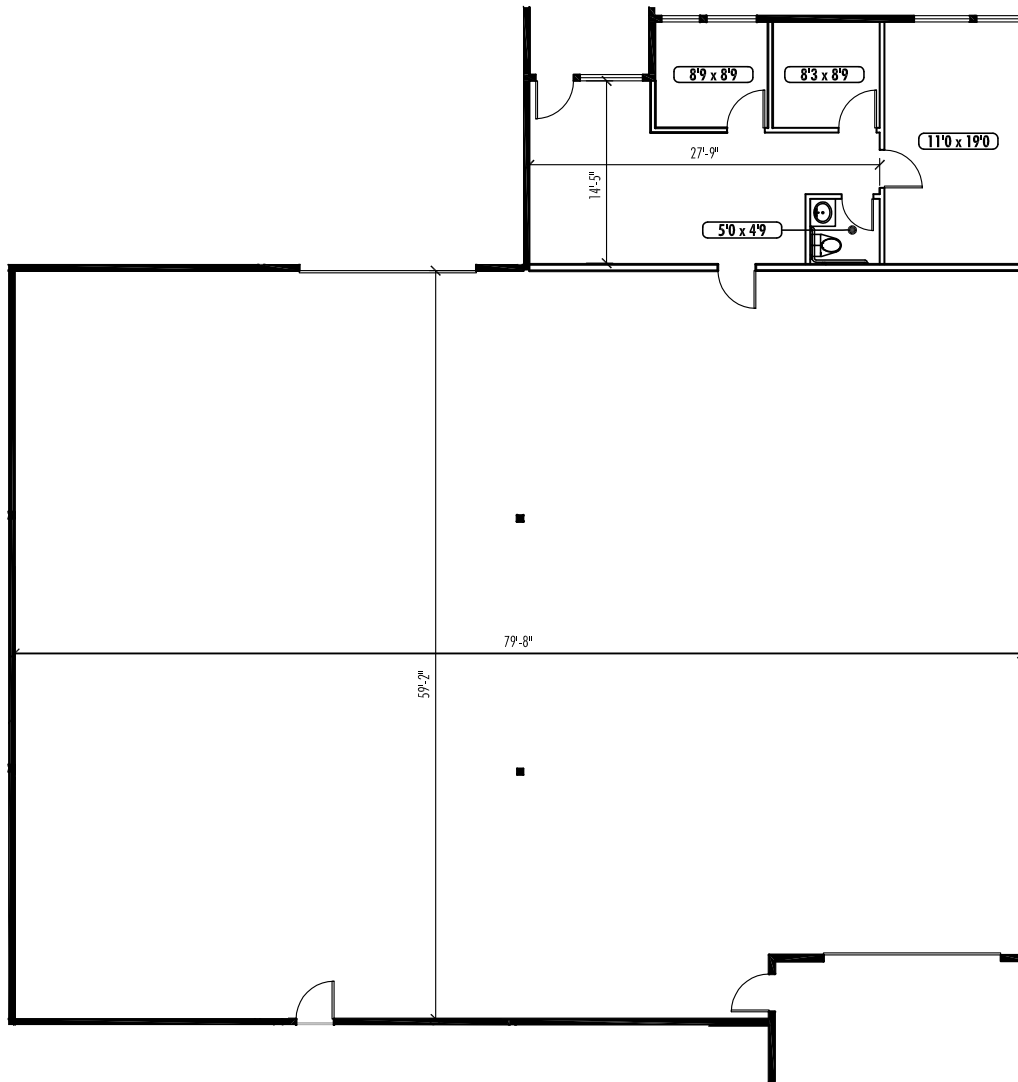

NICK RATZKE, SIOR
253.779.2414
nratzke@neilwalter.com

JOHN DEHAN
253.779.2433
jdehan@neilwalter.com

All information references in this document are approximate. The information contained herein is contained from sources deemed reliable. It is provided without representation, warranty, or guarantee, expressed or implied as to accuracy. Prospective buyer or tenant should conduct its own independent investigation relating to the property, government codes and regulations, allowed uses, and all other matters, regardless of whether they are referred to or contained in this document.

LAKEWOOD BUSINESS PARK

Building A 10107, Building C 10109, Building D 10111, Building E 10029, Building G 10027, Building H 10025, South Tacoma Way
Lakewood, WA

C1/C2 - 5,231 SF

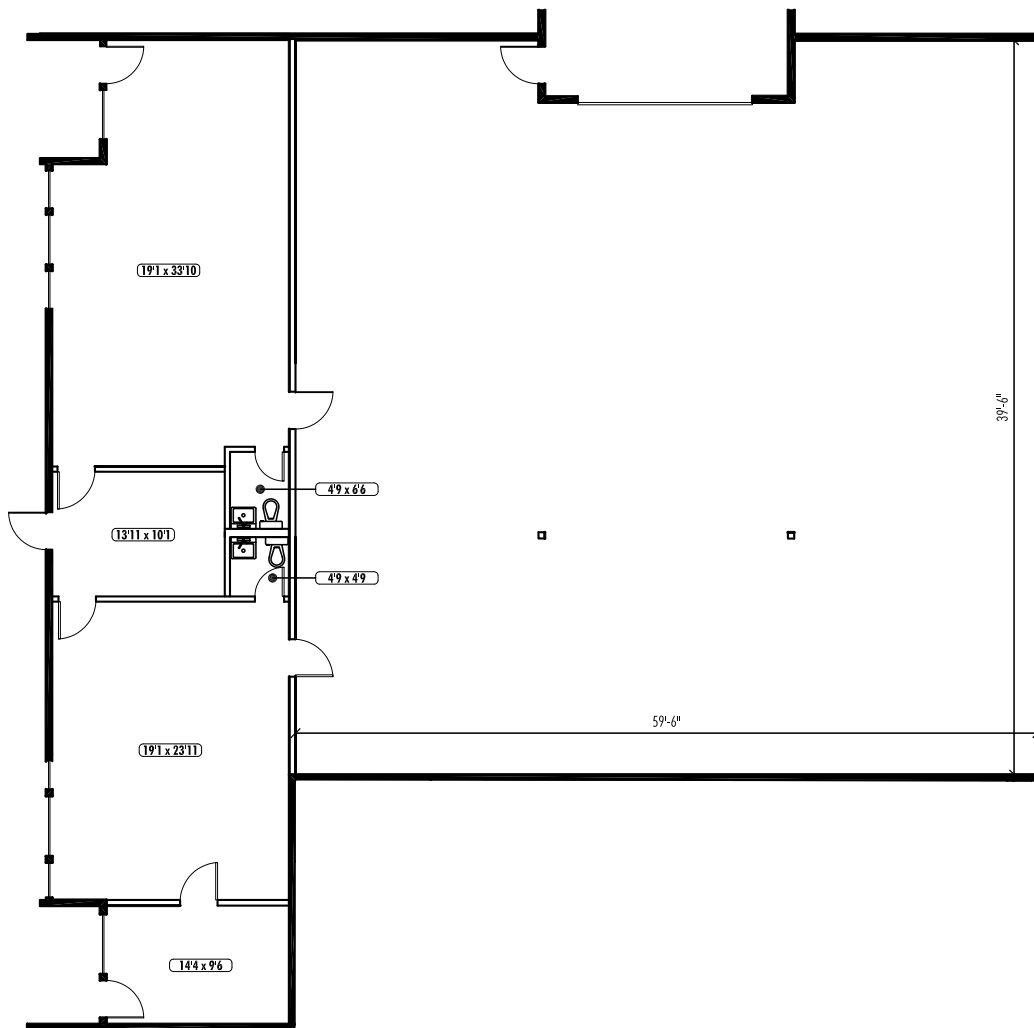

NICK RATZKE, SIOR
253.779.2414
nratzke@neilwalter.com

JOHN DEHAN
253.779.2433
jdehan@neilwalter.com

All information references in this document are approximate. The information contained herein is contained from sources deemed reliable. It is provided without representation, warranty, or guarantee, expressed or implied as to accuracy. Prospective buyer or tenant should conduct its own independent investigation relating to the property, government codes and regulations, allowed uses, and all other matters, regardless of whether they are referred to or contained in this document.

LAKEWOOD BUSINESS PARK

Building A 10107, Building C 10109, Building D 10111, Building E 10029, Building G 10027, Building H 10025, South Tacoma Way
Lakewood, WA

G5/G6 - 3,114 SF

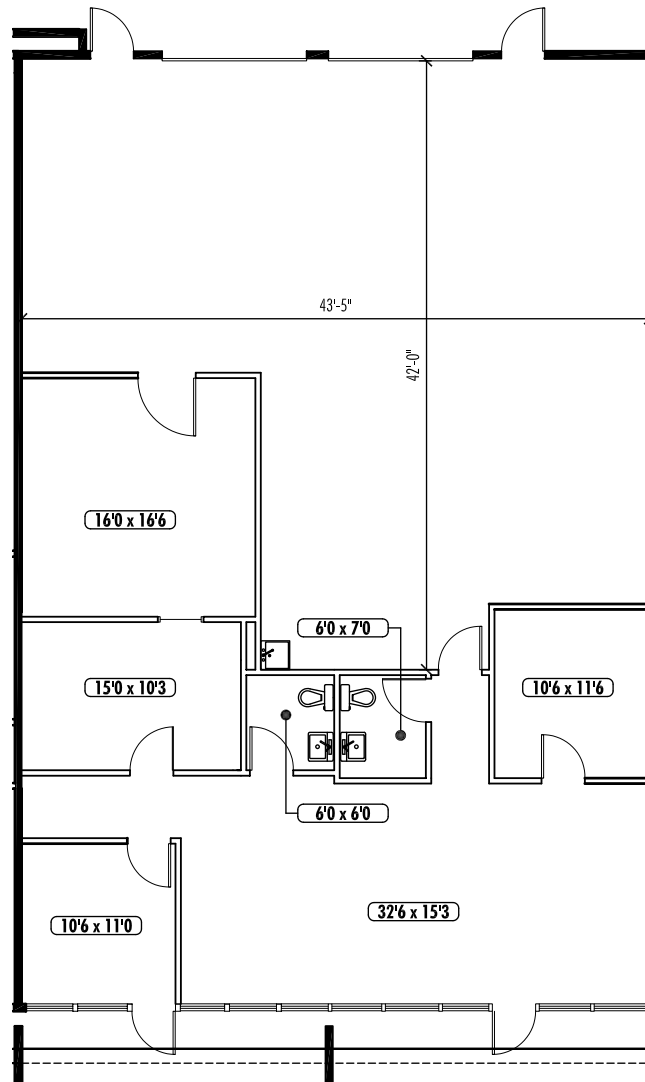

NICK RATZKE, SIOR
253.779.2414
nratzke@neilwalter.com

JOHN DEHAN
253.779.2433
jdehan@neilwalter.com

All information references in this document are approximate. The information contained herein is contained from sources deemed reliable. It is provided without representation, warranty, or guarantee, expressed or implied as to accuracy. Prospective buyer or tenant should conduct its own independent investigation relating to the property, government codes and regulations, allowed uses, and all other matters, regardless of whether they are referred to or contained in this document.

LAKEWOOD BUSINESS PARK

Building A 10107, Building C 10109, Building D 10111, Building E 10029, Building G 10027, Building H 10025, South Tacoma Way
Lakewood, WA

H8 - 2,315 SF

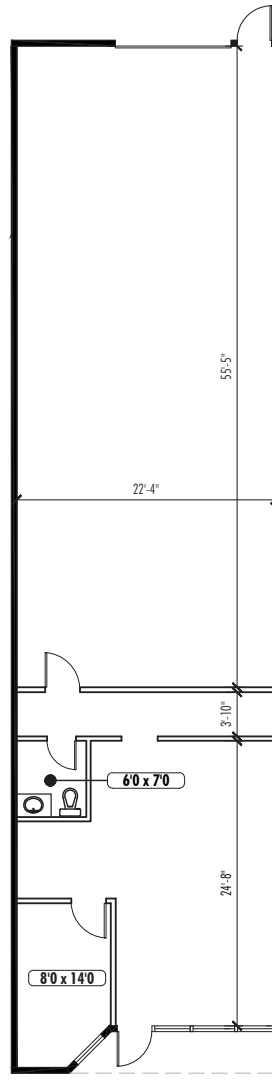

NICK RATZKE, SIOR
253.779.2414
nratzke@neilwalter.com

JOHN DEHAN
253.779.2433
jdehan@neilwalter.com

All information references in this document are approximate. The information contained herein is contained from sources deemed reliable. It is provided without representation, warranty, or guarantee, expressed or implied as to accuracy. Prospective buyer or tenant should conduct its own independent investigation relating to the property, government codes and regulations, allowed uses, and all other matters, regardless of whether they are referred to or contained in this document.

LAKEWOOD BUSINESS PARK

Building A 10107, Building C 10109, Building D 10111, Building E 10029, Building G 10027, Building H 10025, South Tacoma Way
Lakewood, WA

H2 - 1,946 SF

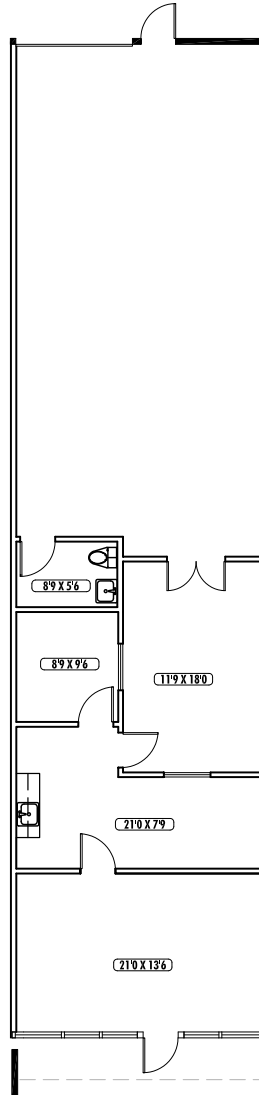

NICK RATZKE, SIOR
253.779.2414
nratzke@neilwalter.com

JOHN DEHAN
253.779.2433
jdehan@neilwalter.com

All information references in this document are approximate. The information contained herein is contained from sources deemed reliable. It is provided without representation, warranty, or guarantee, expressed or implied as to accuracy. Prospective buyer or tenant should conduct its own independent investigation relating to the property, government codes and regulations, allowed uses, and all other matters, regardless of whether they are referred to or contained in this document.

LAKEWOOD BUSINESS PARK

Building A 10107, Building C 10109, Building D 10111, Building E 10029, Building G 10027, Building H 10025, South Tacoma Way
Lakewood, WA

D6 - 815 SF

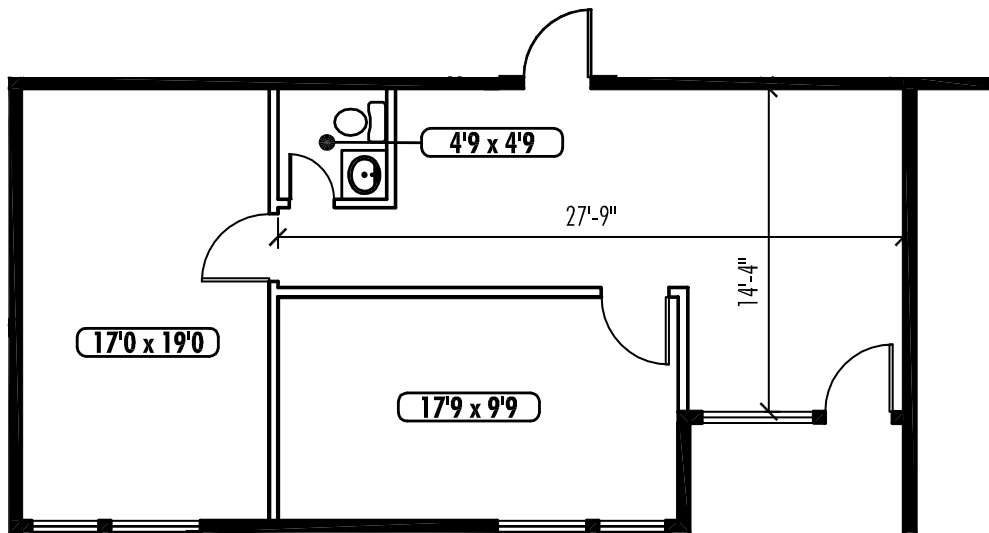

NICK RATZKE, SIOR
253.779.2414
nratzke@neilwalter.com

JOHN DEHAN
253.779.2433
jdehan@neilwalter.com

All information references in this document are approximate. The information contained herein is contained from sources deemed reliable. It is provided without representation, warranty, or guarantee, expressed or implied as to accuracy. Prospective buyer or tenant should conduct its own independent investigation relating to the property, government codes and regulations, allowed uses, and all other matters, regardless of whether they are referred to or contained in this document.

LAKEWOOD BUSINESS PARK

Building A 10107, Building C 10109, Building D 10111, Building E 10029, Building G 10027, Building H 10025, South Tacoma Way
Lakewood, WA



NICK RATZKE, SIOR
253.779.2414
nratzke@neilwalter.com

JOHN DEHAN
253.779.2433
jdehan@neilwalter.com

All information references in this document are approximate. The information contained herein is contained from sources deemed reliable. It is provided without representation, warranty, or guarantee, expressed or implied as to accuracy. Prospective buyer or tenant should conduct its own independent investigation relating to the property, government codes and regulations, allowed uses, and all other matters, regardless of whether they are referred to or contained in this document.