



Woodinville Corporate Park

15300–15500 & 16240–16750 Woodinville-Redmond Rd

Space Available
For Lease Within a
928,000 SF Class-A
Industrial Park



SCAN TO VIEW WEBSITE

woodinvillecorporatepark.com

 Kidder
Mathews



12 State-of-the-Art,
Freestanding, Dock-High,
Class-A Industrial Buildings in
Woodinville's Premier Location

928,000 SF

Total Size of Park



Loading door
ratio: 1 door per
3,067 SF



24' clear height



Excellent
truck courts



Parking ratio:
1.35 stalls per
1,000 SF



Highlights

Best-in-class industrial on the Eastside

- Easy access to SR-522 & I-405
- Situated close to downtown Woodinville amenities
- Market leading functionality: true 24' clear, dock + grade loading, with excellent truck courts

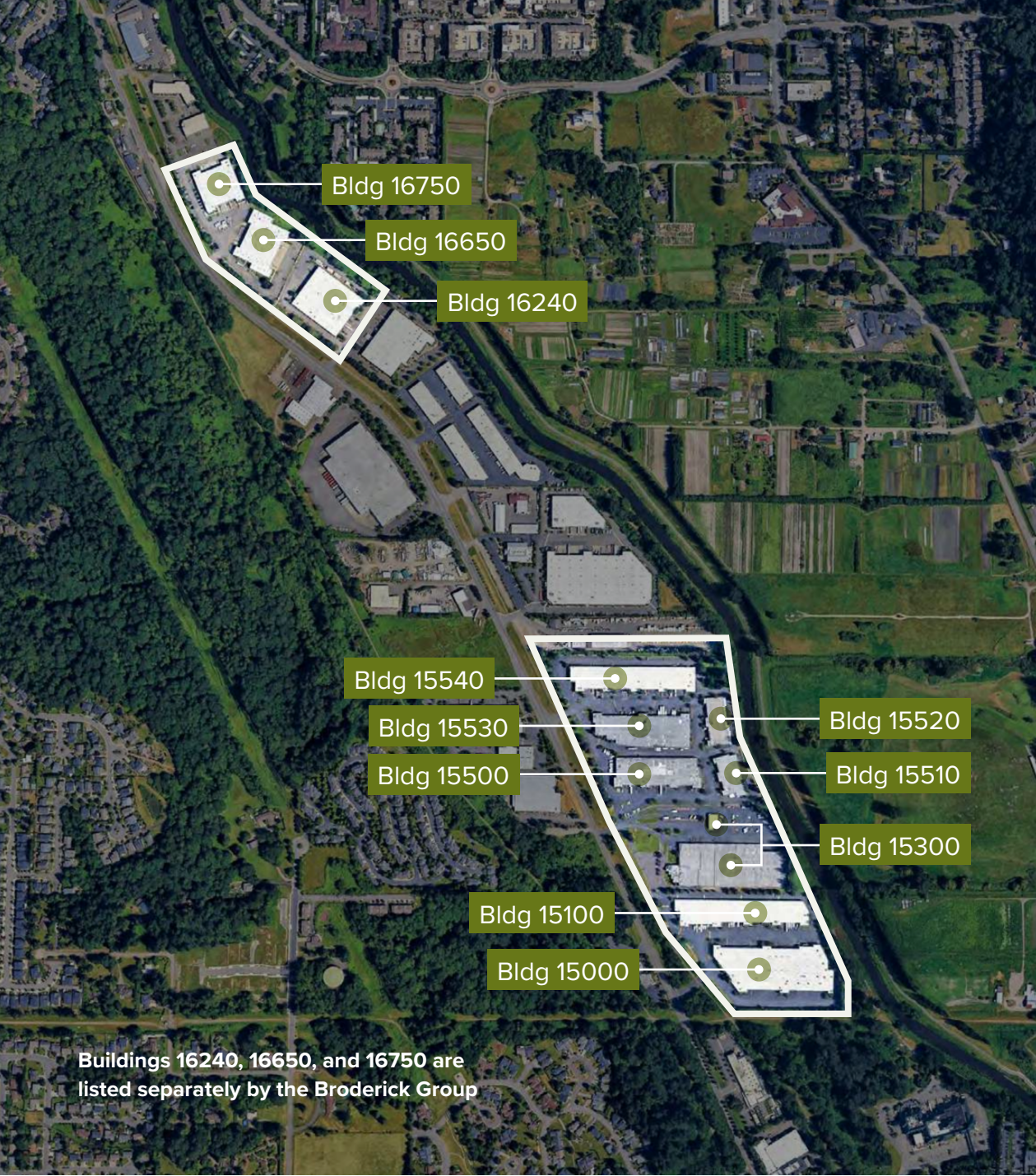

Buildings 16240, 16650, and 16750 are listed separately by the Broderick Group



Building 15000 Suite 900

First Floor

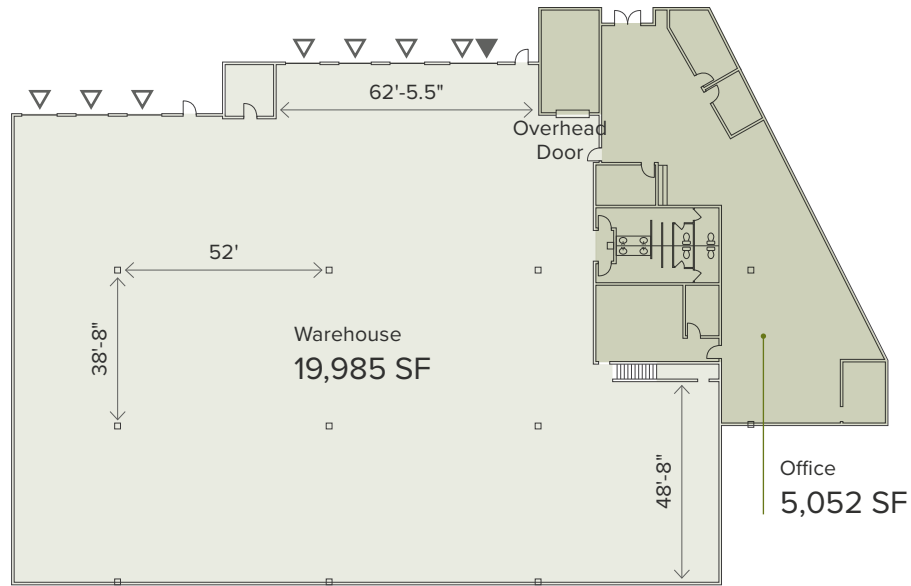

Mezzanine

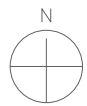
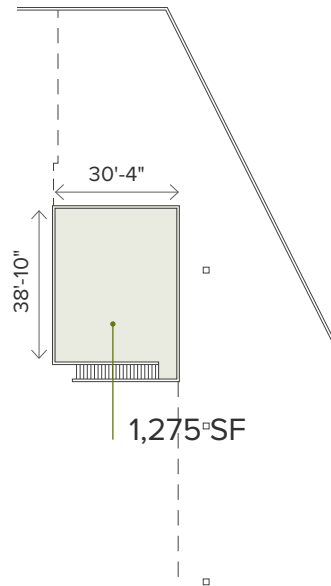

- Office
- Warehouse
- Dock-High Loading
- Grade-Level Loading

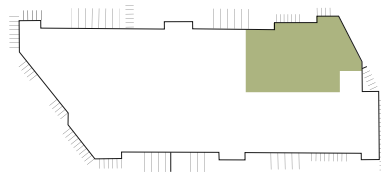

Available Now
Call for Rates

Planned improvements

- New carpet
- New paint
- New LED lighting
- New ceiling tiles
- 24' clear height
- 7 dock high / 1 grade level
- 200 amps, 480V, 3-phase power

First-Floor Office	5,052 SF
Second-Floor Mezz.	1,275 SF
Warehouse	19,985 SF
Total Space	26,312 SF



Building 15100 Suite 600

First Floor

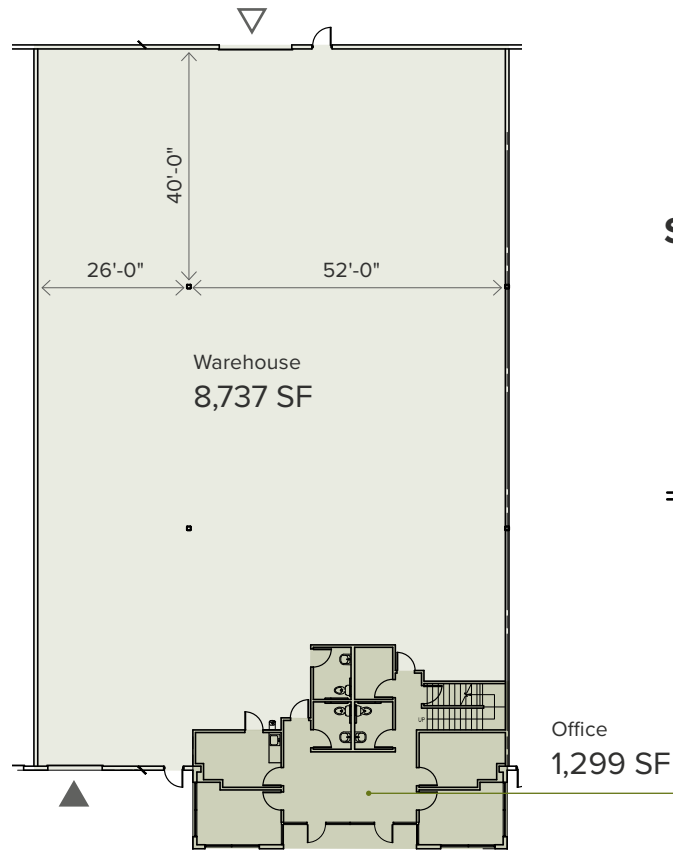

Second Floor Office

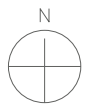
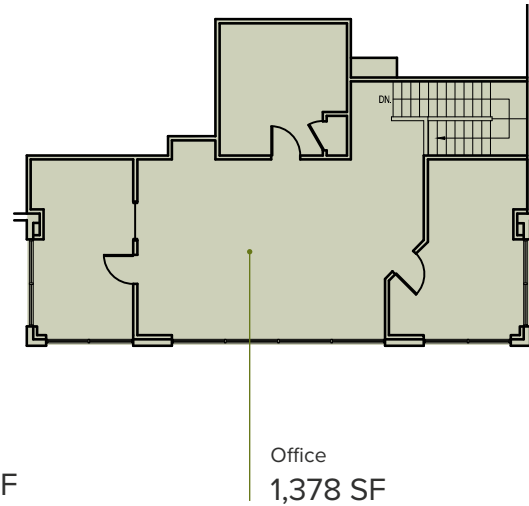

- Office
- Warehouse
- Dock-High Loading
- Grade-Level Loading

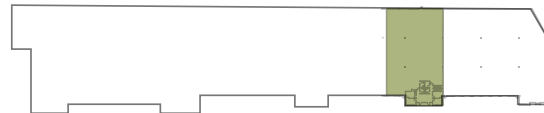

Available Now
Call for Rates

Features

- New carpet
- New paint
- New LED lighting
- 24' clear height
- 1 dock high / 1 grade level

First-Floor Office	1,299 SF
Second-Floor Office	1,378 SF
Warehouse	8,737 SF
Total Space	11,414 SF



Building 15500 Suite 100

First Floor

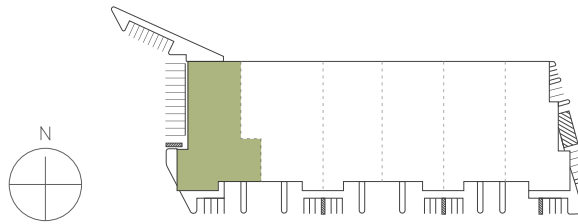
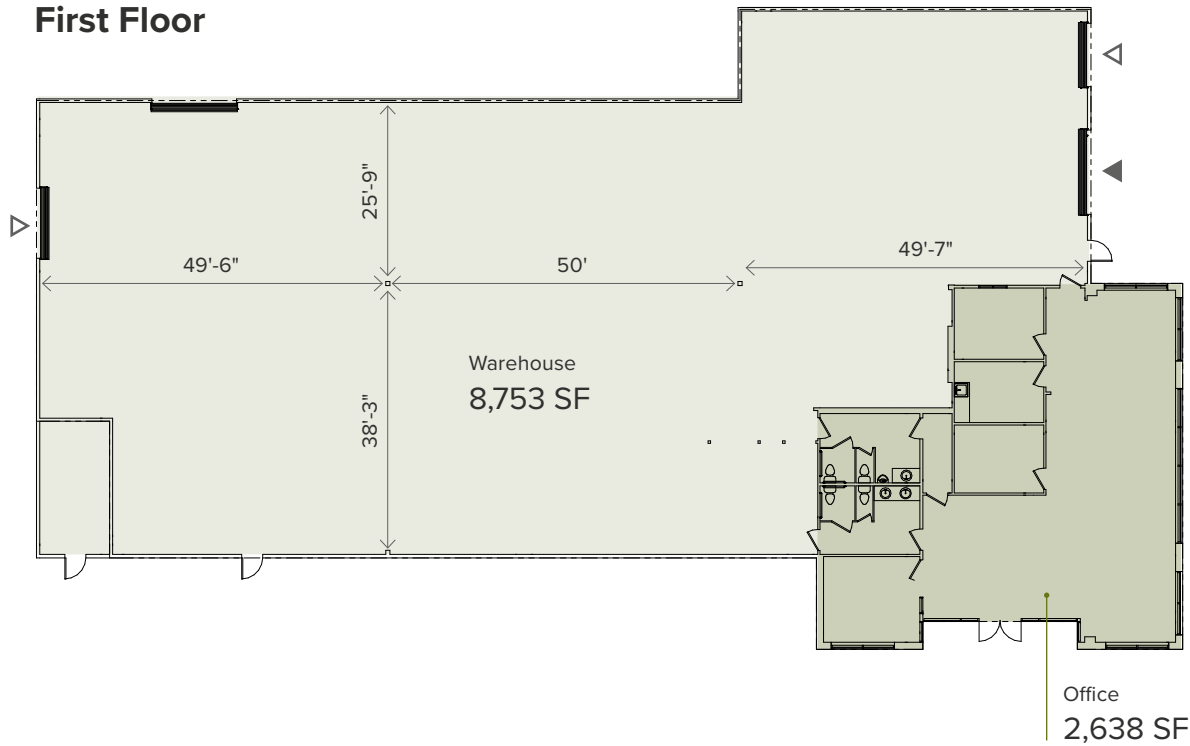

Available Now
Call for Rates

Planned Improvements

- New carpet
- New paint
- New LED lighting
- 24' clear height
- 2 dock high / 1 grade level
- 200 amps, 480V 3-phase meter/panel (expandable to 400 amps)

Office	2,638 SF
Warehouse	8,753 SF
Total Space	11,391 SF



Building 15500

Suites 200/300/400

Available Now
Call for Rates

Planned Improvements

- New LED lighting
- New warehouse finishes
- New office finishes
- New carpet
- Divisible space—
12,934–41,426 SF available
- 24' clear height
- 10 dock high / 3 grade level
- 600 amps, 480V

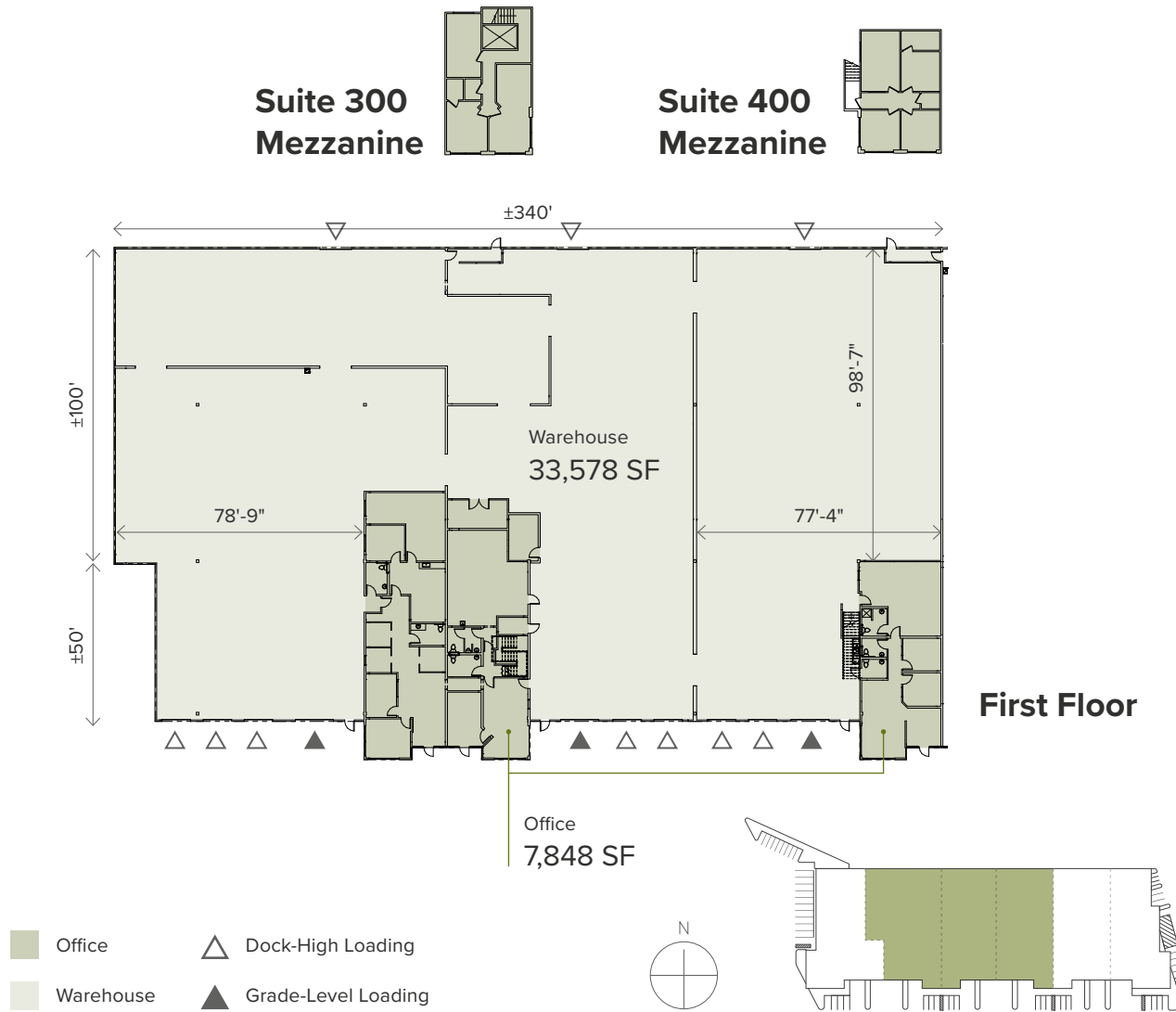

Office	7,848 SF
Warehouse	33,578 SF
Total Space	41,426 SF



Building 15520 Suite 100

First Floor

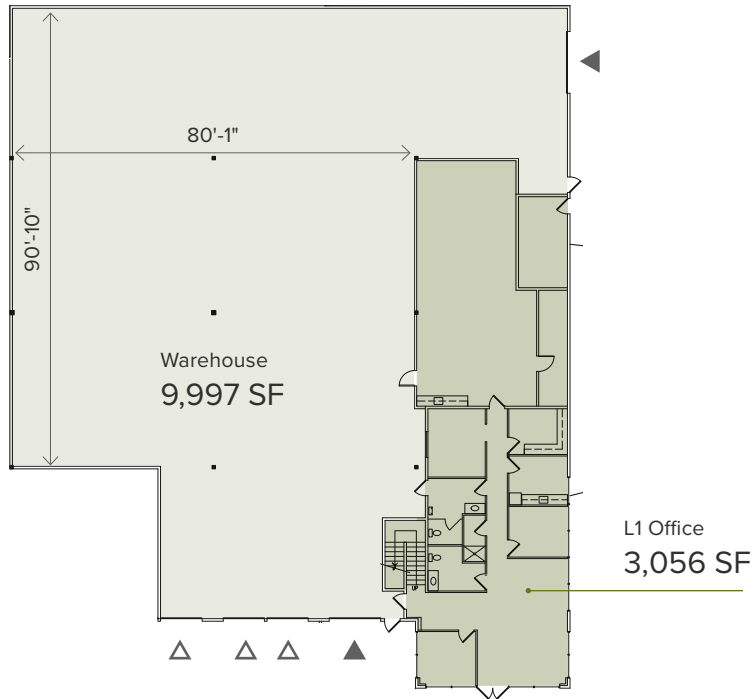

Second Floor Office

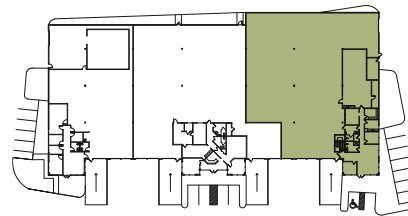
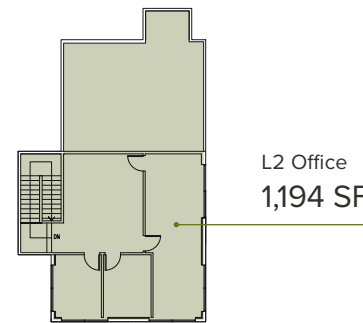

- Office
- Warehouse
- Dock-High Loading
- Grade-Level Loading



Available 7/1/26
Call for Rates

Features

- New roof
- New warehouse LEDs and paint
- New office finishes
- 24' clear height
- 3 dock high / 2 grade level
- 500 amps, 480V, 3-phase power

First Floor Office	3,056 SF
Second Floor Office	1,194 SF
Warehouse	9,997 SF
Total Space	14,247 SF



Building 15530 Suite 300

First Floor

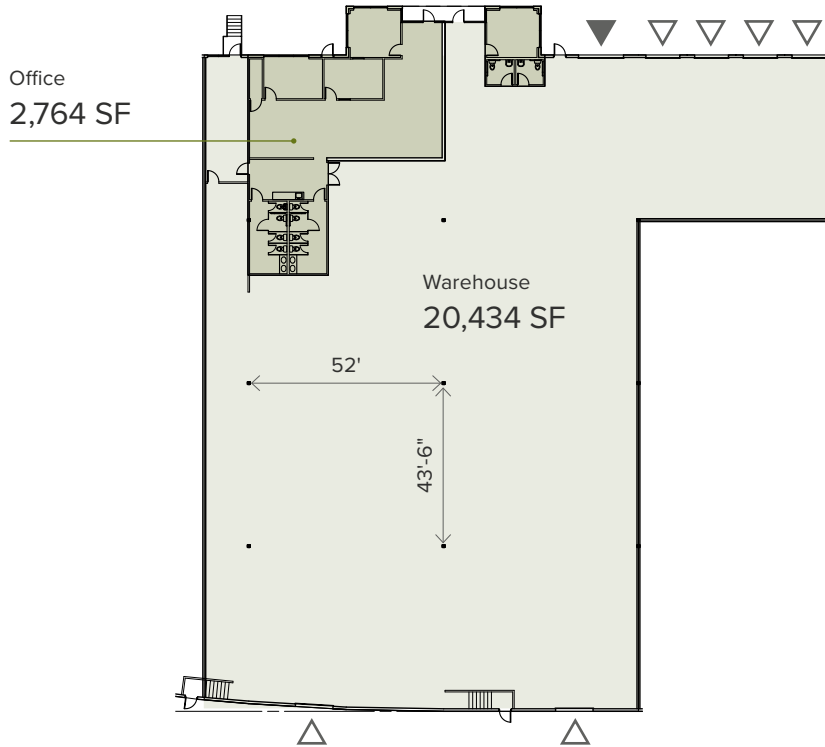

Available 10/1/26
Call for Rates

Planned improvements

- New warehouse LEDs and paint
- New office finishes
- 24' clear height
- 6 dock high / 1 grade level
- 300 amps, 480V, 3-phase power

Office	2,764 SF
Warehouse	20,434 SF
Total Space	23,198 SF



Building 15300 + Yard

First Floor

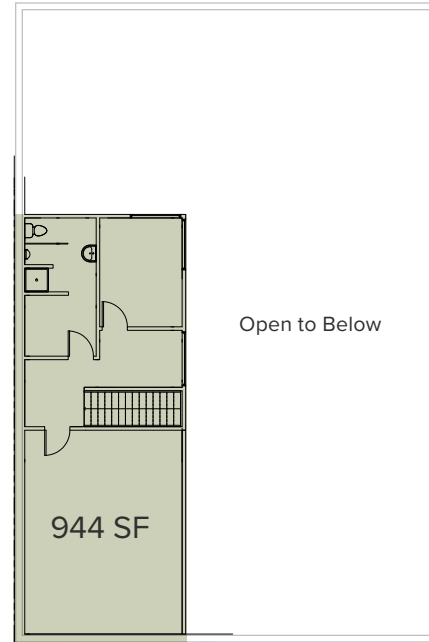
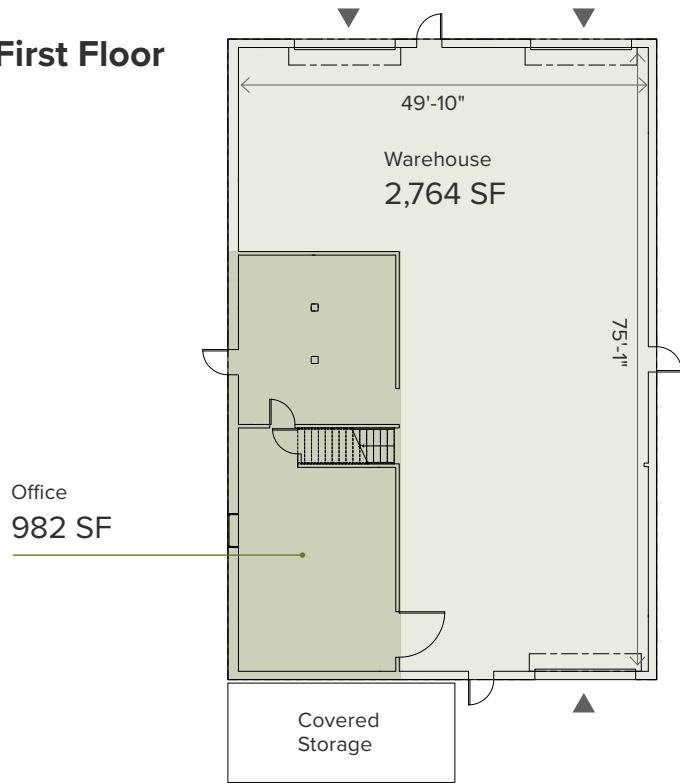

Mezzanine

- Office
- Warehouse
- Grade-Level Loading

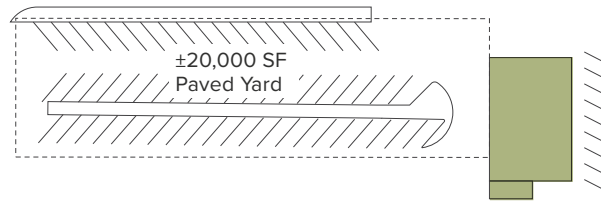
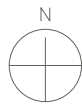

Available
30 Days Notice
Call for Rates

Features

- Stand-alone building with 20,000 SF of paved yard (can be fenced)
- 3 grade-level doors
- Includes outside covered storage area

First Floor Office	982 SF
Unfinished Mezz.	944 SF
Warehouse	2,764 SF
Total Space	4,690 SF



Upcoming Park Improvements



New Landscaping



Refreshed Building
Exteriors



New Park Signage



Local Institutional
Ownership



Tenant Experience
Upgrades



Mechanical & Roof
Upgrades





Nearby Amenities

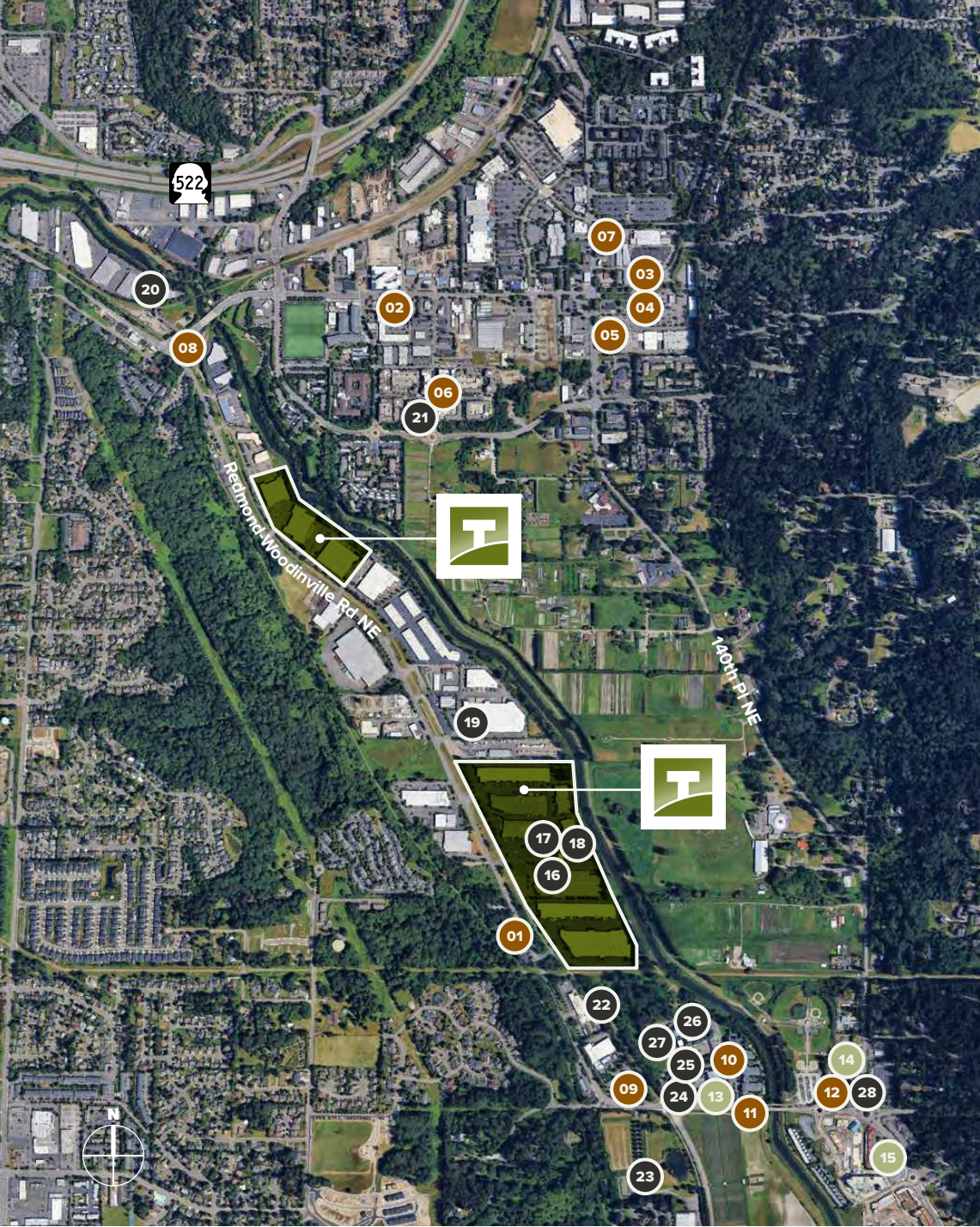

EAT & DRINK

- 01 Von's 1000Spirits
- 02 The Pizza Coop & Ale House
- 03 Woodinville Café
- 04 Topsy Cow
- 05 Pasta Nova Italiano
- 06 Rusty Pelican Café
- 07 Dough Zone
- 08 Woodinville Cut Shop
- 09 Hollywood Tavern
- 10 Barking Frog
- 11 The Herbfarm
- 12 Vivi Pizzeria

LODGING

- 13 Willows Lodge
- 14 Hollywood Manor at Tenhulzen Reserve
- 15 The Somm

WINERIES & BREWERIES

- 16 Tenor Wines
- 17 Watts Brewing Company
- 18 Black Raven Brewing
- 19 Martedi Winery
- 20 Rocky Pond Estate Winery
- 21 Novelty Hill – Januik Winery
- 22 Chateau Ste. Michelle Winery
- 23 Mark Ryan Winery
- 24 Fidélitas
- 25 DeLille Cellars
- 26 Sparkman Cellars
- 27 Latta Wines
- 28 Patterson Cellars



Drive Times

Located in the heart of Woodinville, with convenient drive-time access to top restaurants, retail, and key amenities



Owner Profile



Industrial Real Estate
Focused on **Location**,
Functionality, and
Flexibility.

307

Buildings

20.2M

Square Feet

44

Improved
Land Parcels

676

Customers

Terreno Realty acquires,
owns and operates
industrial real estate in six
major coastal U.S. markets.

These properties may be warehouse/distribution, flex
(including light industrial and R&D), transshipment
(truck terminals) or improved land parcels.

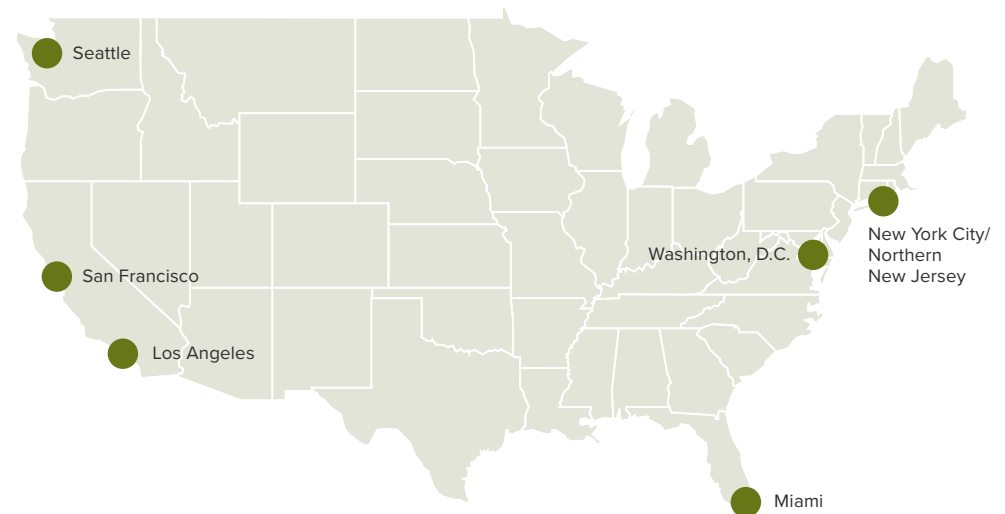

[LEARN MORE AT TERRENO.COM](https://www.terreno.com)





Woodinville Corporate Park

15300 – 15500 Woodinville-Redmond Rd
Woodinville, WA 98072

woodinvillecorporatemark.com kidder.com

Exclusively listed by

Todd Gauthier
Executive Vice President
425.450.1118
todd.gauthier@kidder.com

Jason Bloom
Executive Vice President
425.450.1102
jason.bloom@kidder.com

Carter Nicholson
Associate
425.450.1145
carter.nicholson@kidder.com

Greg Fuchs
Associate
425.450.1161
greg.fuchs@kidder.com



SCAN TO
LEARN MORE



This information supplied herein is from sources we deem reliable. It is provided without any representation, warranty, or guarantee, expressed or implied as to its accuracy. Prospective Buyer or Tenant should conduct an independent investigation and verification of all matters deemed to be material, including, but not limited to, statements of income and expenses. Consult your attorney, accountant, or other professional advisor.