

From start-ups to enterprise ventures, Westpark welcomes you

CAMPUS AVAILABILITIES

OFFICE		LEASABLE SF
15241 NE 90th Street BUILDING R	Suite 160	1,151 RSF Small office space, 2 private offices, conference/kitchen and internal restrooms.
8561 154th Avenue NE BUILDING J	Suite 210	1,541 RSF Market-ready 2nd floor office space, furniture potentially available.
8345 154th Avenue NE BUILDING F	Suite 160	4,133 RSF 2nd floor office on extensive window line, move-in ready condition.
15365 NE 90th Street BUILDING T	Suite 200	9,239 RSF 2nd floor office on extensive window line, includes small 604 SF warehouse for storage with grade-level loading.
8271 154th Avenue NE BUILDING D	Suites 200/250	22,625 RSF Full floor available, divisible to 7,715 SF and 14,910 SF. Landlord will reconfigure space to suit tenant's needs.
8620 154th Avenue NE BUILDING N	Suite 200	33,700 RSF Full floor, move-in ready with class A tech finishes, mix of open area, conference rooms, private offices, open ceiling, completely remodeled.
SHORT-TERM EXECUTIVE OFFICE SUITES		LEASABLE SF
8441 154th Avenue NE BUILDING H	Suites 201-209	2-6 person suites Fully-furnished shared space with flexible lease terms and fully serviced rates (including utilities). Access to in-building communal meeting spaces, fitness facility with showers and towel service, and coffee service, ready-to-occupy Wi-Fi and phone hook-up.
FLEX/INDUSTRIAL		LEASABLE SF
15365 NE 90th Street BUILDING T	Suite 120	2,051 RSF Total 1,530 RSF Office 521 RSF Warehouse Small office/warehouse space off the lobby, 3 private offices, testing area, warehouse with grade-level loading.

☕ = Dote To-Go | 🧑‍🤝‍🧑 = Westpark Hub/Pavilion



From start-ups to enterprise ventures, Westpark welcomes you

CAMPUS AVAILABILITIES (CONT.)

FLEX/INDUSTRIAL		LEASABLE SF
8561 154th Avenue NE BUILDING J	Suite 130	2,865 RSF Total 1,591 RSF Office 1,275 RSF Warehouse Great small flex space with open office space, kitchen, and warehouse with grade-level loading
8531 154th Avenue NE BUILDING K	Suite 150	2,886 RSF Total 1,822 RSF Office 1,064 RSF Warehouse 3 private offices, conference room, kitchen, and warehouse with grade loading
8531 154th Avenue NE BUILDING K	Suite 110	3,557 RSF Total 3,200 RSF Office 357 RSF Warehouse 3 sides of extensive window line on 1st floor, small 357 SF warehouse for additional storage.
15223 NE 90th Street BUILDING U	Suite 140	4,108 RSF Total 2,258 RSF Office 1,850 RSF Warehouse Outstanding small flex space with high-end finishes with 3 private offices, conference room, kitchen, and warehouse with grade loading.
8635 154th Avenue NE BUILDING O	Suite 120	4,931 RSF Total 909 RSF Office 4,022 RSF Warehouse Rare small warehouse with office space, dock- and grade level loading. 24' clear height.
8620 154th Avenue NE BUILDING N	Suite 150	5,360 RSF Total Former commissary kitchen space with existing Type 1 hood and kitchen buildout. Can be converted to flex R&D/Open Office space. Fully conditioned space.
15365 NE 90th Street BUILDING T	Suite 110	7,530 RSF Total 7,177 RSF Office 353 RSF Warehouse R&D/Flex space with small warehouse, grade-level loading, temp controlled R&D area with polished concrete floors. Move-in ready condition.
8620 154th Avenue NE BUILDING N	Suite 105/110	7,708 RSF Total Flex R&D space with dock- and grade-level loading, high-end finishes, and move-in ready condition.

 = Dote To-Go |
  = Westpark Hub/Pavilion



= FLEX SPACE AVAILABILITY

From start-ups to enterprise ventures, Westpark welcomes you

CAMPUS AVAILABILITIES (CONT.)

FLEX/INDUSTRIAL		LEASABLE SF
8410 154th Avenue NE BUILDING C	Suite 120	7,756 RSF Total 5,417 RSF Office 2,339 RSF Warehouse Market-ready space, newly built out, extensive window line with 2,339 SF warehouse, 2 grade-level doors and a shared dock door.
8510 154th Avenue NE BUILDING M	Suite 100	11,107 RSF Total Office/R&D/Lab on first floor, high-level finishes, and dock and grade-level loading. Dust collection system, compressed air systems.
8510 154th Avenue NE BUILDING M	Suite 200	21,727 RSF Total Office/Lab on second floor, incredible finishes, furniture available.
8210 154th Avenue NE BUILDING A	Suites 100/230	32,412 RSF Total 16,922 RSF Office 15,490 RSF Warehouse Rare production, R&D and warehousing space. Dock and grade-level loading, 24' clear height, heavy power, flex layout.

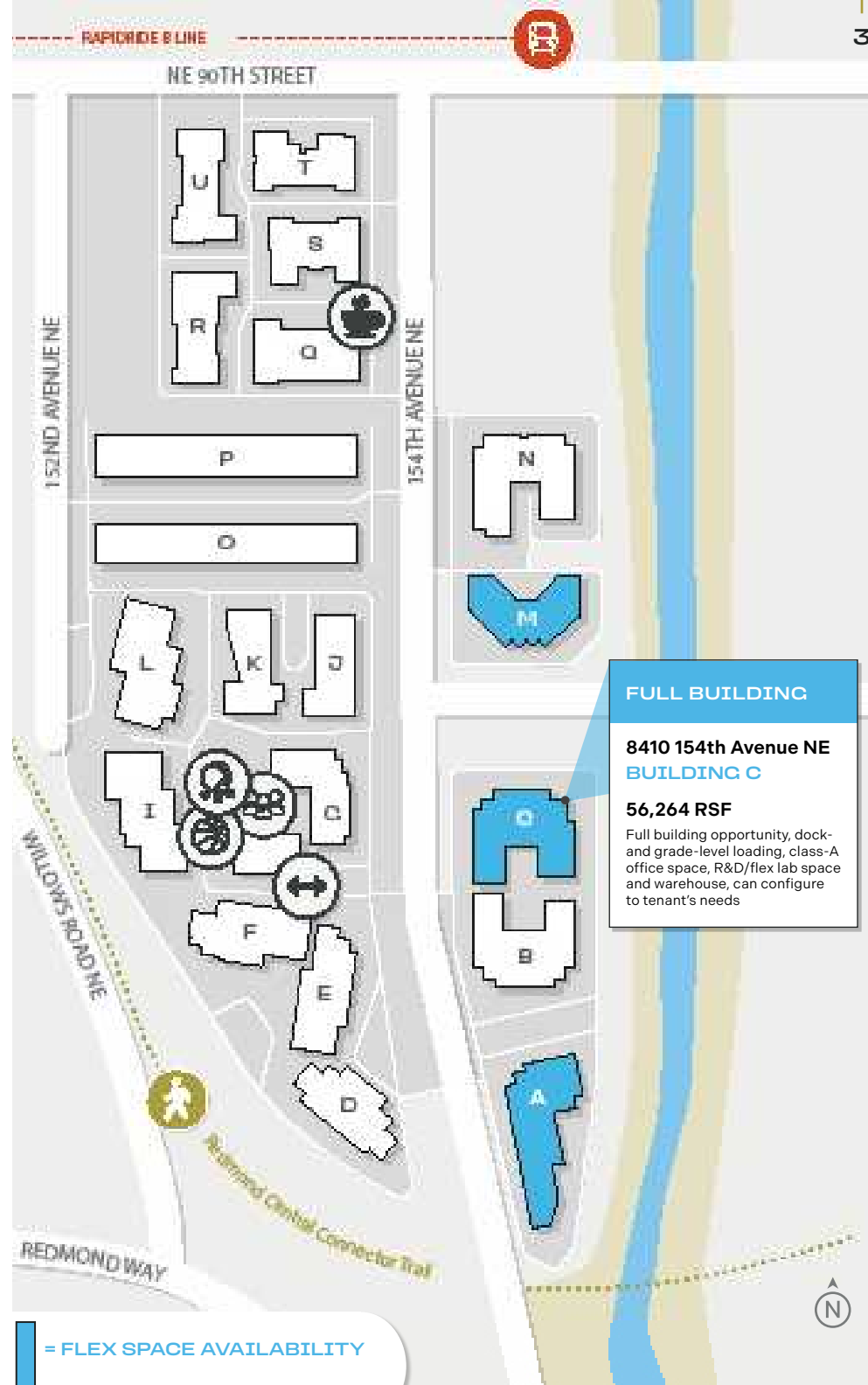

☕ = Dote To-Go | 👤 ↕ 🏀 🏠 = Westpark Hub/Pavilion

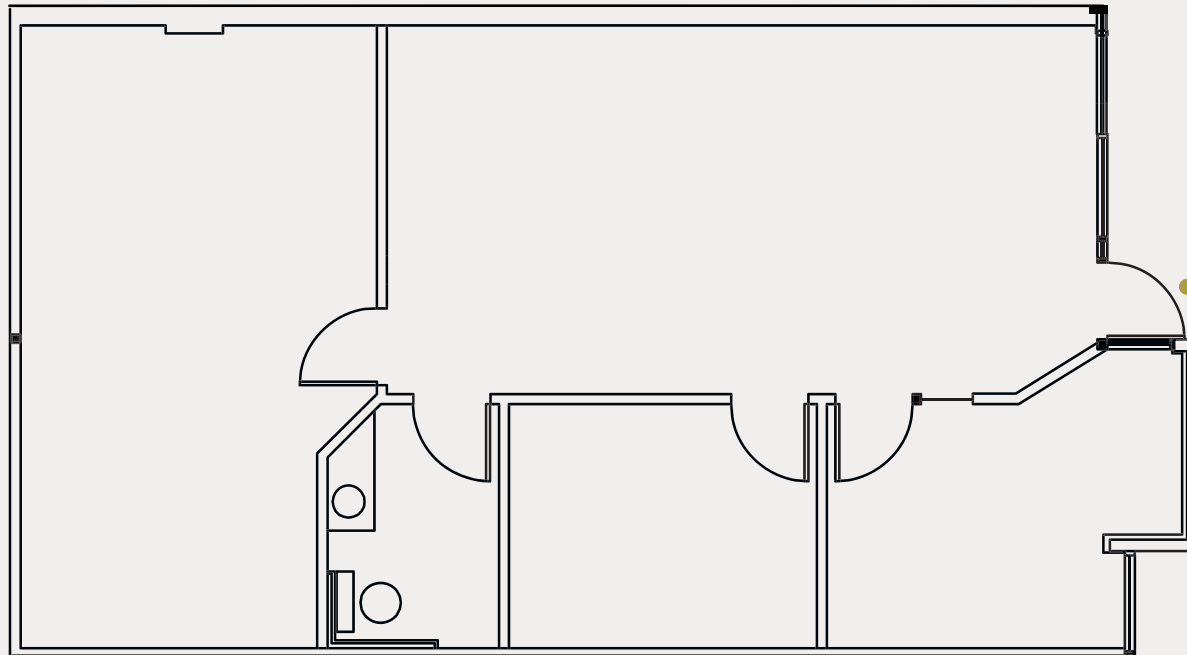

PRIMARY ENTRANCE

KEY PLANS

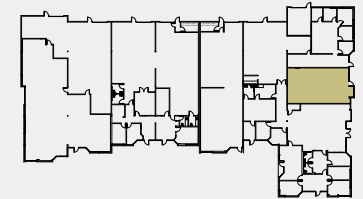

JASON BLOOM

425.450.1102 | jason.bloom@kidder.com | westparkredmond.com

DRAWING NOT TO SCALE

As-built subject to field verification

UPDATED 05.2026 | This information supplied herein is from sources we deem reliable. It is provided without any representation, warranty, or guarantee, expressed or implied as to its accuracy. Prospective Buyer or Tenant should conduct an independent investigation and verification of all matters deemed to be material, including, but not limited to, statements of income and expenses. Consult your attorney, accountant, or other professional advisor.

Westpark

BUILDING J

8561 154th Avenue NE
Redmond, WA

BUILD OUT NOTES:
Market-ready 2nd floor office space,
furniture potentially available.

Suite 210
1,541 RSF

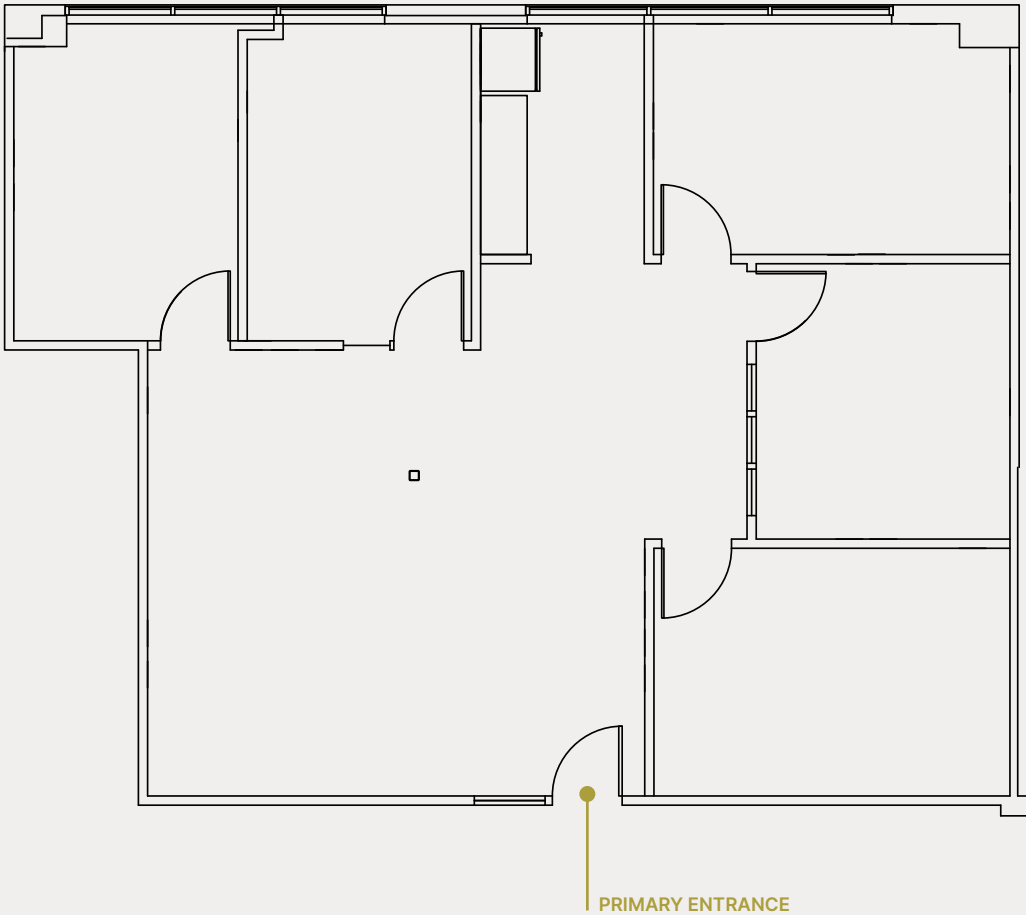

KEY PLANS



JASON BLOOM

425.450.1102 | jason.bloom@kidder.com | westparkredmond.com

DRAWING NOT TO SCALE

As-built subject to field verification

UPDATED 05.2026 | This information supplied herein is from sources we deem reliable. It is provided without any representation, warranty, or guarantee, expressed or implied as to its accuracy. Prospective Buyer or Tenant should conduct an independent investigation and verification of all matters deemed to be material, including, but not limited to, statements of income and expenses. Consult your attorney, accountant, or other professional advisor.



Westpark

BUILDING F

8345 154th Avenue NE
Redmond, WA

BUILD OUT NOTES:
2nd floor office on extensive window line,
move-in ready condition.

Suite 160
4,133 RSF

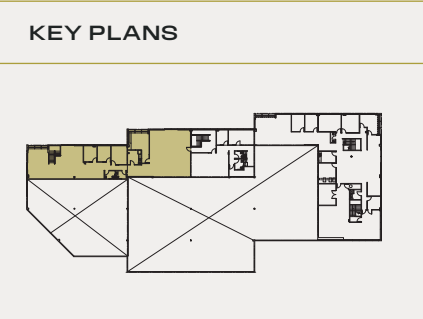
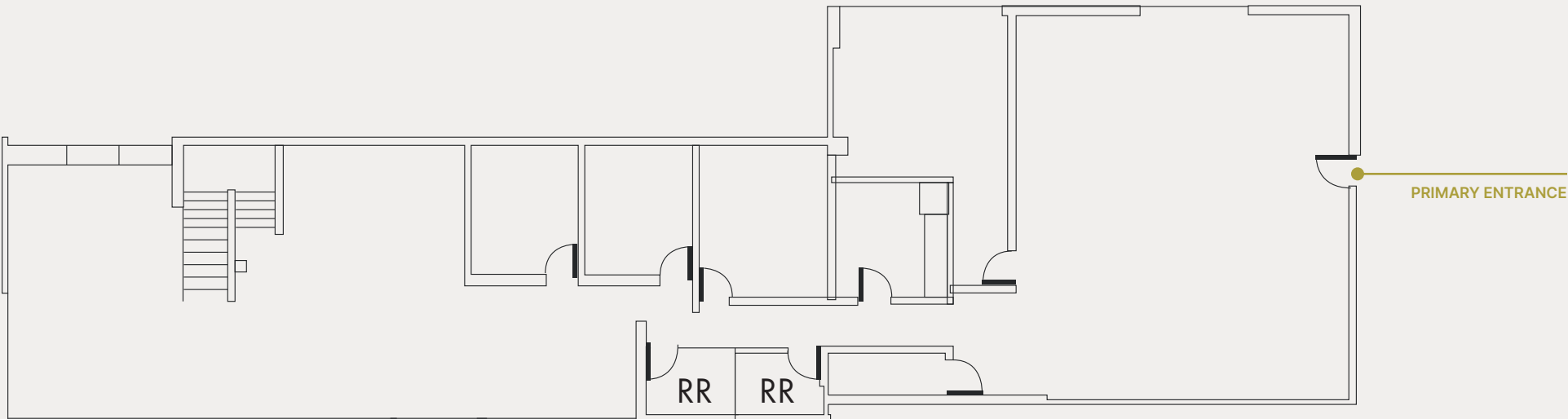

JASON BLOOM
425.450.1102 | jason.bloom@kidder.com | westparkredmond.com

DRAWING NOT TO SCALE
As-built subject to field verification

UPDATED 05.2026 | This information supplied herein is from sources we deem reliable. It is provided without any representation, warranty, or guarantee, expressed or implied as to its accuracy. Prospective Buyer or Tenant should conduct an independent investigation and verification of all matters deemed to be material, including, but not limited to, statements of income and expenses. Consult your attorney, accountant, or other professional advisor.



Westpark

BUILDING T

15365 NE 90th Street
Redmond, WA

BUILD OUT NOTES:
2nd floor office on extensive window line,
includes small 604 RSF warehouse for
storage with grade-level loading.

Suite 200
9,239 RSF

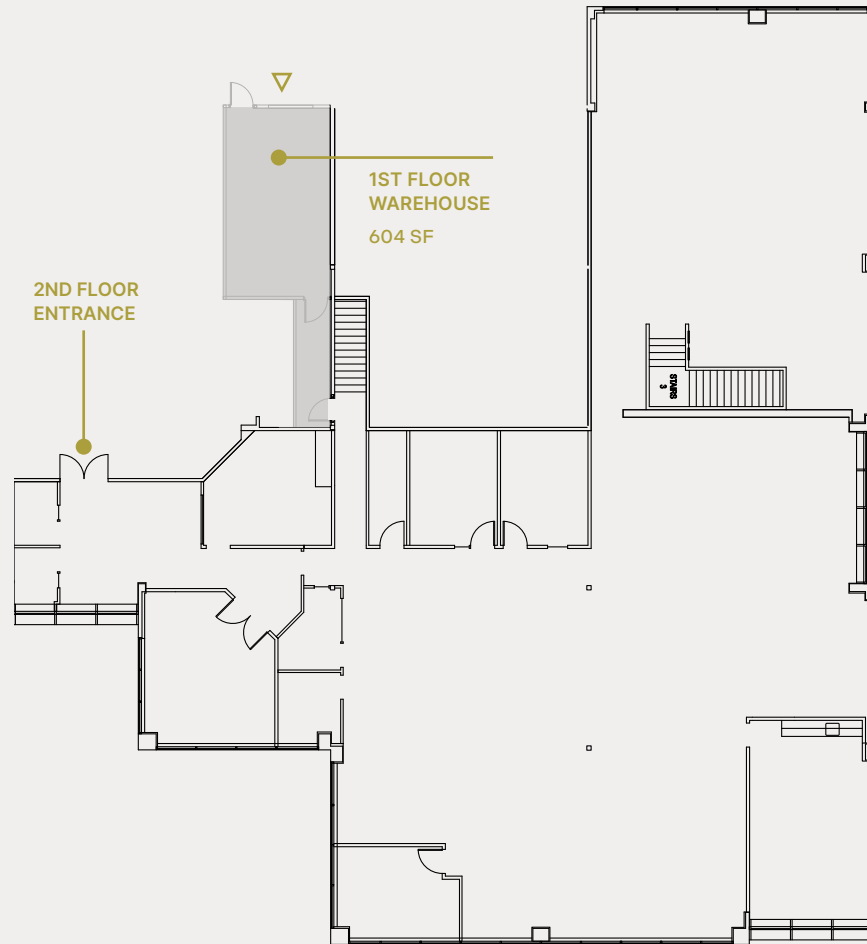

△ GRADE LEVEL

KEY PLANS

2ND FLOOR

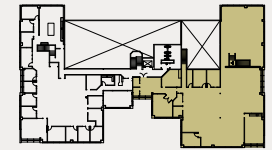

1ST FLOOR

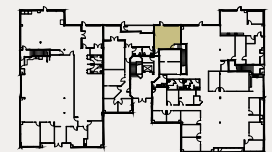

JASON BLOOM

425.450.1102 | jason.bloom@kidder.com | westparkredmond.com

DRAWING NOT TO SCALE

As-built subject to field verification

UPDATED 05.2026 | This information supplied herein is from sources we deem reliable. It is provided without any representation, warranty, or guarantee, expressed or implied as to its accuracy. Prospective Buyer or Tenant should conduct an independent investigation and verification of all matters deemed to be material, including, but not limited to, statements of income and expenses. Consult your attorney, accountant, or other professional advisor.



Westpark

BUILDING D

8271 154th Avenue NE
Redmond, WA

BUILD OUT NOTES:

Full floor available, divisible to 7,715 RSF
and 14,910 RSF. Landlord will reconfigure
space to suit tenant's needs.

Suites
200/205
22,625 RSF



JASON BLOOM

425.450.1102 | jason.bloom@kidder.com | westparkredmond.com

DRAWING NOT TO SCALE

As-built subject to field verification

UPDATED 05.2026 | This information supplied herein is from sources we deem reliable. It is provided without any representation, warranty, or guarantee, expressed or implied as to its accuracy. Prospective Buyer or Tenant should conduct an independent investigation and verification of all matters deemed to be material, including, but not limited to, statements of income and expenses. Consult your attorney, accountant, or other professional advisor.



Westpark

BUILDING N

8620 154th Avenue NE
Redmond, WA

BUILD OUT NOTES:

Full floor, move-in ready with class A tech finishes, mix of open area, conference rooms, private offices, open ceiling, completely remodeled.

Suite 200
33,700 RSF

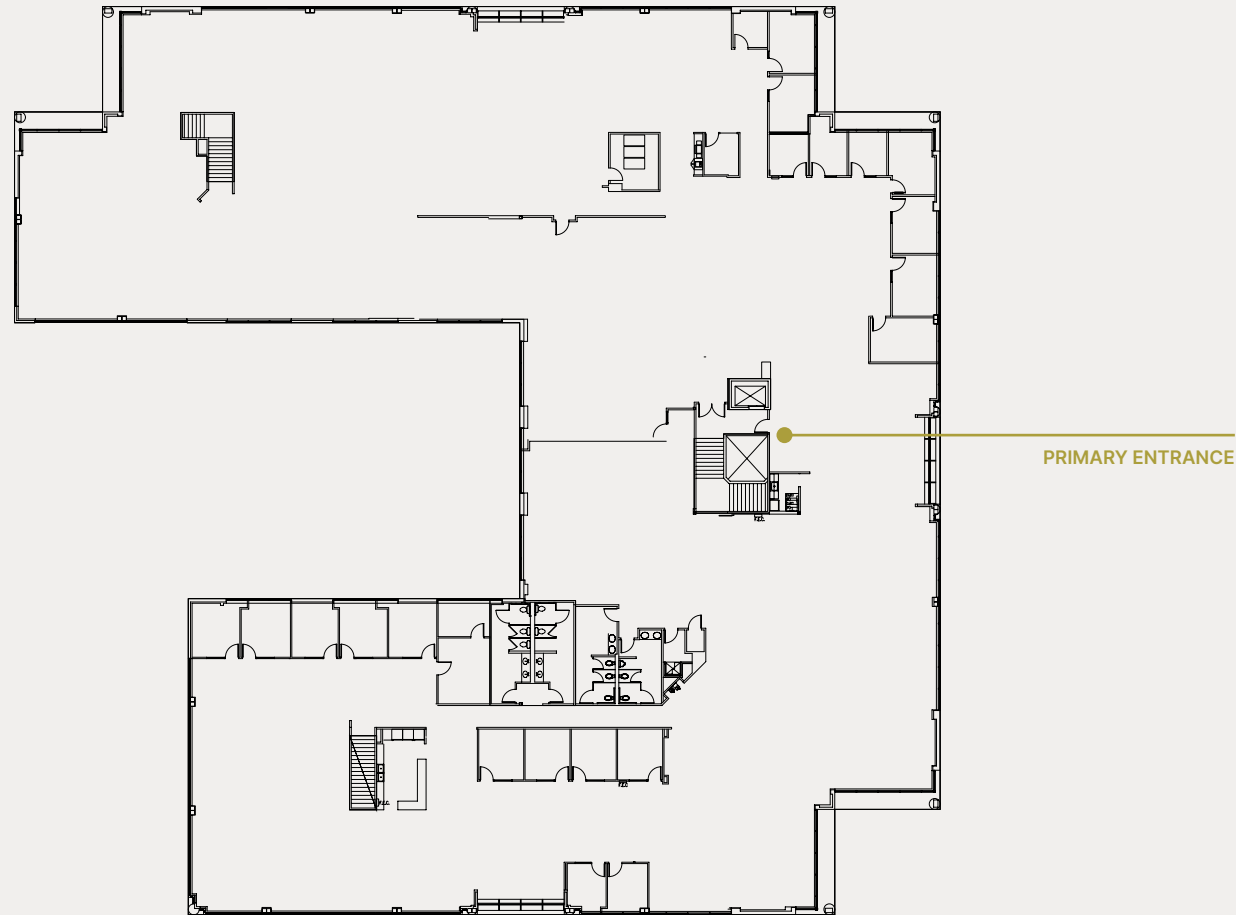

JASON BLOOM

425.450.1102 | jason.bloom@kidder.com | westparkredmond.com

DRAWING NOT TO SCALE

As-built subject to field verification

UPDATED 05.2026 | This information supplied herein is from sources we deem reliable. It is provided without any representation, warranty, or guarantee, expressed or implied as to its accuracy. Prospective Buyer or Tenant should conduct an independent investigation and verification of all matters deemed to be material, including, but not limited to, statements of income and expenses. Consult your attorney, accountant, or other professional advisor.



Westpark

BUILDING H

8441 154th Avenue NE
Redmond, WA

BUILD OUT NOTES:
Fully-furnished shared space with flexible lease terms and fully serviced rates (including utilities).

Suites 201/209

2-6 person
Short-Term Suites

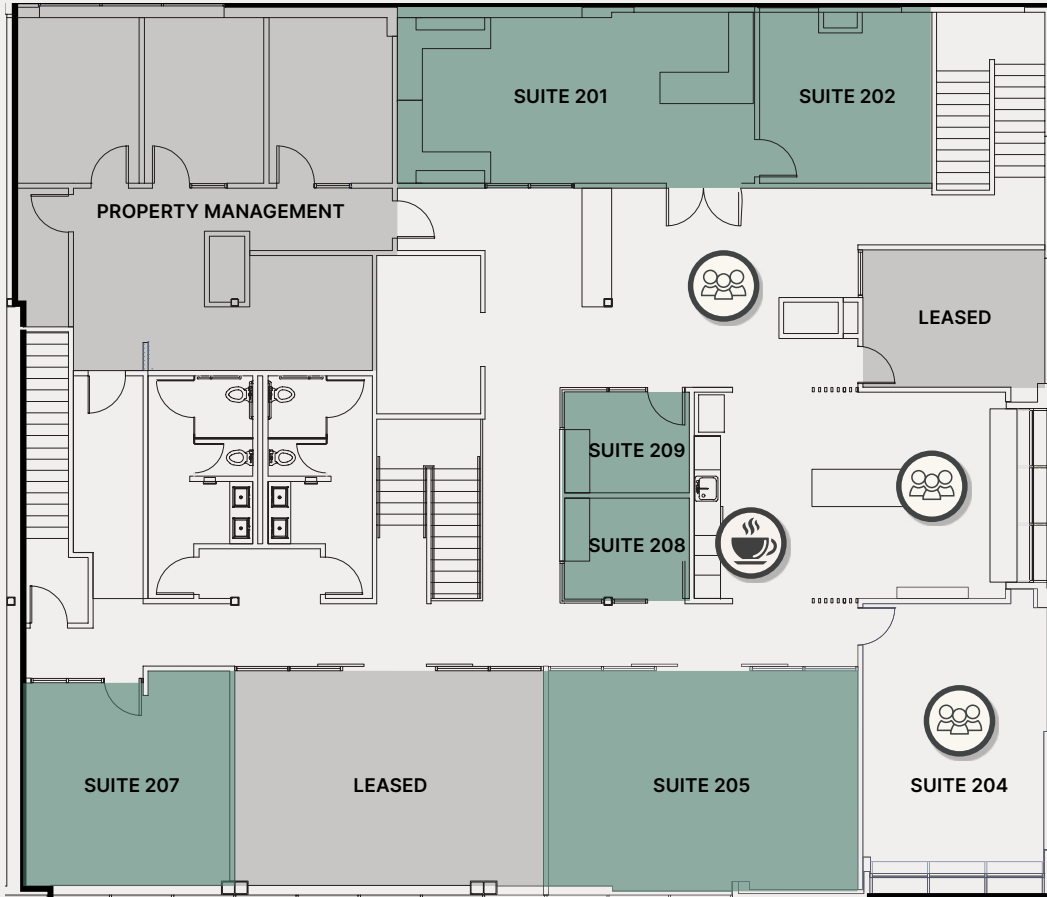

NOTES:
Access to in-building communal meeting spaces, fitness facility with showers and towel service, and coffee service, ready-to-occupy WiFi and phone hook-up.

JASON BLOOM

425.450.1102 | jason.bloom@kidder.com | westparkredmond.com

DRAWING NOT TO SCALE

As-built subject to field verification

UPDATED 05.2026 | This information supplied herein is from sources we deem reliable. It is provided without any representation, warranty, or guarantee, expressed or implied as to its accuracy. Prospective Buyer or Tenant should conduct an independent investigation and verification of all matters deemed to be material, including, but not limited to, statements of income and expenses. Consult your attorney, accountant, or other professional advisor.



Westpark

BUILDING J

8561 154th Avenue NE
Redmond, WA

BUILD OUT NOTES:
Great small flex space with open office space, kitchen, and warehouse with grade-level loading.

Suite 130
2,865 RSF

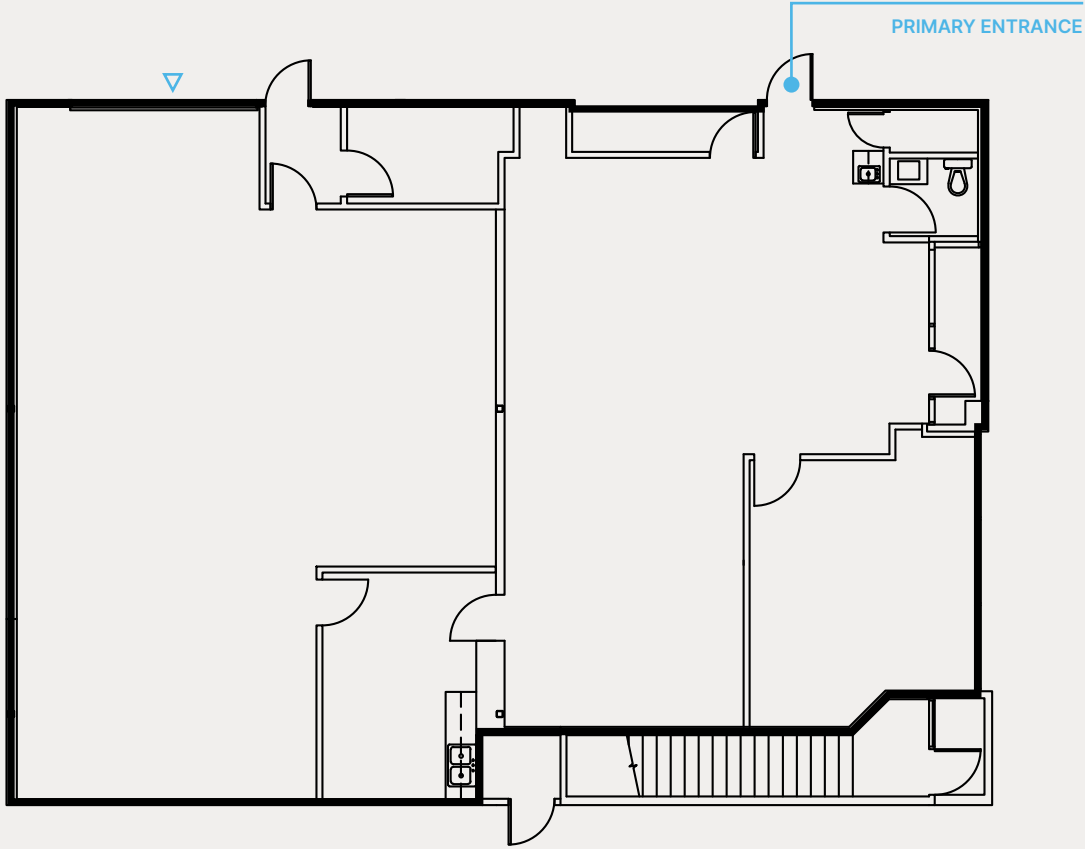

1,591 RSF OFFICE
1,275 RSF WAREHOUSE
▲ GRADE LEVEL

KEY PLANS

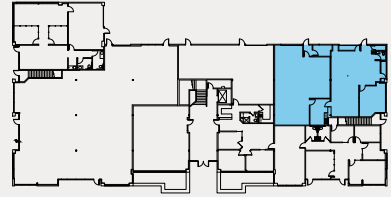

JASON BLOOM

425.450.1102 | jason.bloom@kidder.com | westparkredmond.com

DRAWING NOT TO SCALE
As-built subject to field verification

UPDATED 05.2026 | This information supplied herein is from sources we deem reliable. It is provided without any representation, warranty, or guarantee, expressed or implied as to its accuracy. Prospective Buyer or Tenant should conduct an independent investigation and verification of all matters deemed to be material, including, but not limited to, statements of income and expenses. Consult your attorney, accountant, or other professional advisor.



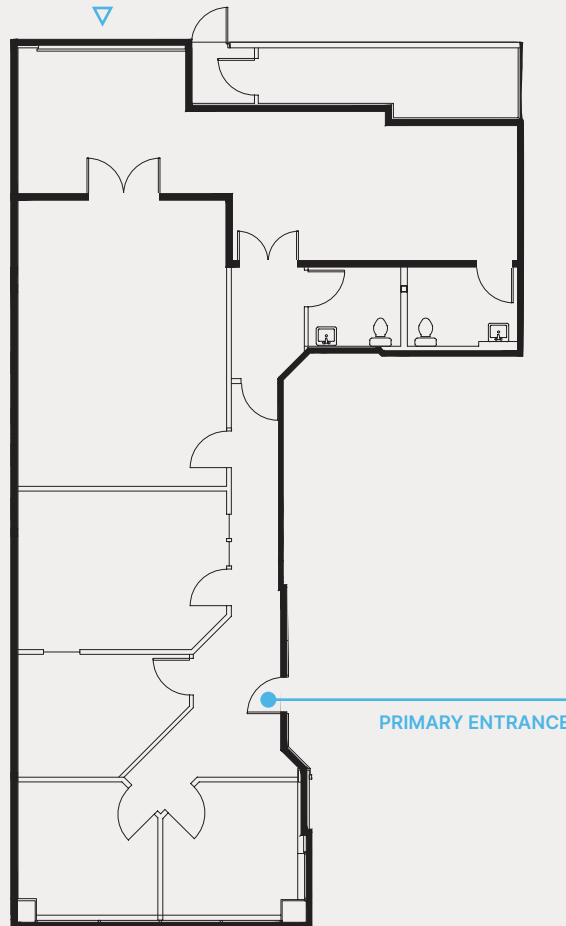

1,530 RSF OFFICE
521 RSF WAREHOUSE
▲ GRADE LEVEL

KEY PLANS

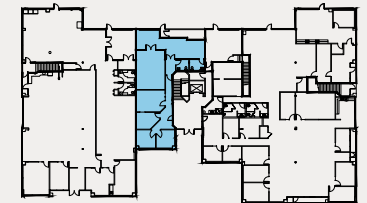

JASON BLOOM

425.450.1102 | jason.bloom@kidder.com | westparkredmond.com

DRAWING NOT TO SCALE

As-built subject to field verification

UPDATED 05.2026 | This information supplied herein is from sources we deem reliable. It is provided without any representation, warranty, or guarantee, expressed or implied as to its accuracy. Prospective Buyer or Tenant should conduct an independent investigation and verification of all matters deemed to be material, including, but not limited to, statements of income and expenses. Consult your attorney, accountant, or other professional advisor.

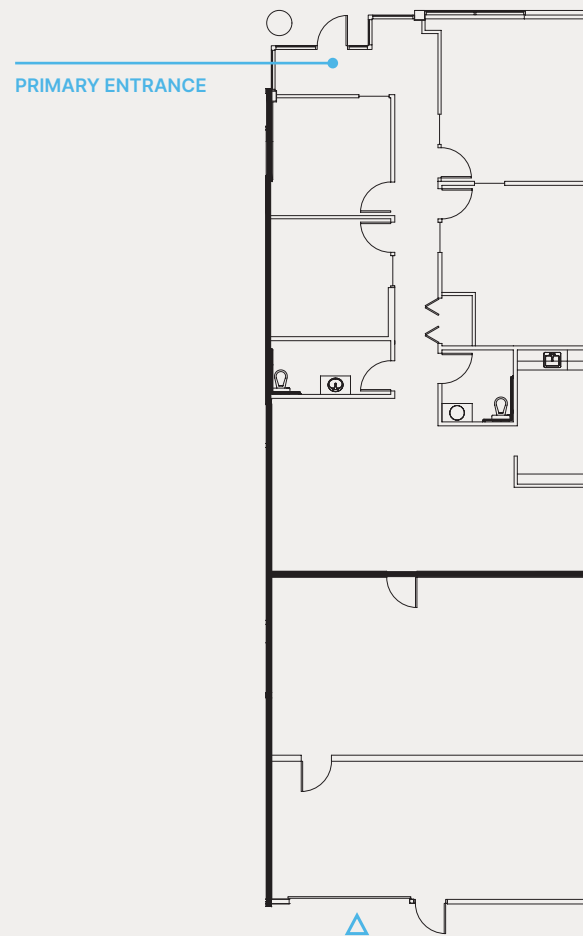

1,822 RSF OFFICE
1,064 RSF WAREHOUSE
▲ GRADE LEVEL

KEY PLANS

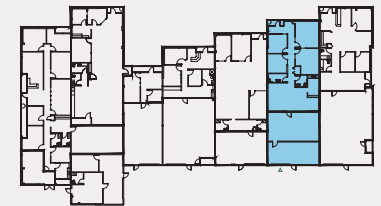

JASON BLOOM

425.450.1102 | jason.bloom@kidder.com | westparkredmond.com

DRAWING NOT TO SCALE

As-built subject to field verification

UPDATED 05.2026 | This information supplied herein is from sources we deem reliable. It is provided without any representation, warranty, or guarantee, expressed or implied as to its accuracy. Prospective Buyer or Tenant should conduct an independent investigation and verification of all matters deemed to be material, including, but not limited to, statements of income and expenses. Consult your attorney, accountant, or other professional advisor.

3,200 RSF OFFICE
357 RSF WAREHOUSE

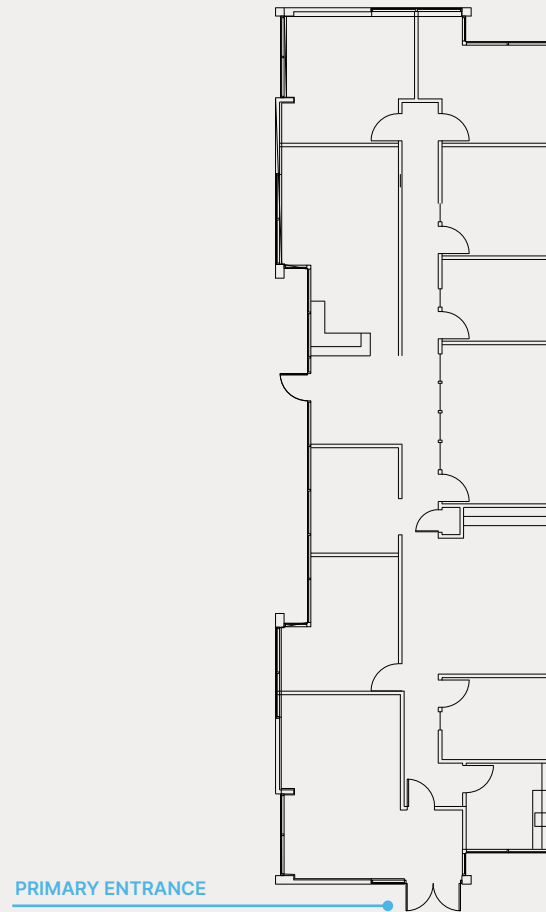

KEY PLANS

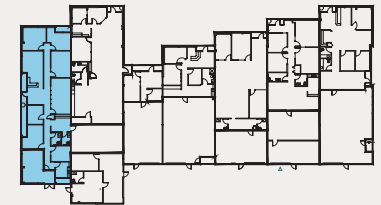

JASON BLOOM

425.450.1102 | jason.bloom@kidder.com | westparkredmond.com

DRAWING NOT TO SCALE

As-built subject to field verification

UPDATED 05.2026 | This information supplied herein is from sources we deem reliable. It is provided without any representation, warranty, or guarantee, expressed or implied as to its accuracy. Prospective Buyer or Tenant should conduct an independent investigation and verification of all matters deemed to be material, including, but not limited to, statements of income and expenses. Consult your attorney, accountant, or other professional advisor.

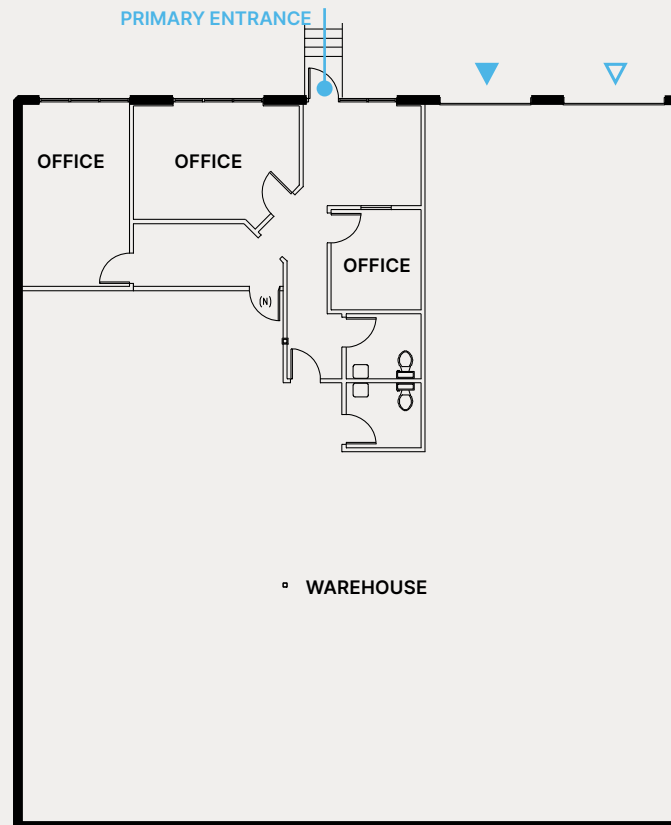

909 RSF OFFICE
4,022 RSF WAREHOUSE
△ GRADE LEVEL
▲ DOCK LEVEL

KEY PLANS



JASON BLOOM

425.450.1102 | jason.bloom@kidder.com | westparkredmond.com

DRAWING NOT TO SCALE

As-built subject to field verification

UPDATED 05.2026 | This information supplied herein is from sources we deem reliable. It is provided without any representation, warranty, or guarantee, expressed or implied as to its accuracy. Prospective Buyer or Tenant should conduct an independent investigation and verification of all matters deemed to be material, including, but not limited to, statements of income and expenses. Consult your attorney, accountant, or other professional advisor.

BUILD OUT NOTES:

Outstanding small flex space with high-end finishes with 3 private offices, conference room, kitchen, and warehouse with grade-level loading.

2,258 RSF OFFICE
1,850 RSF WAREHOUSE
▲ GRADE LEVEL

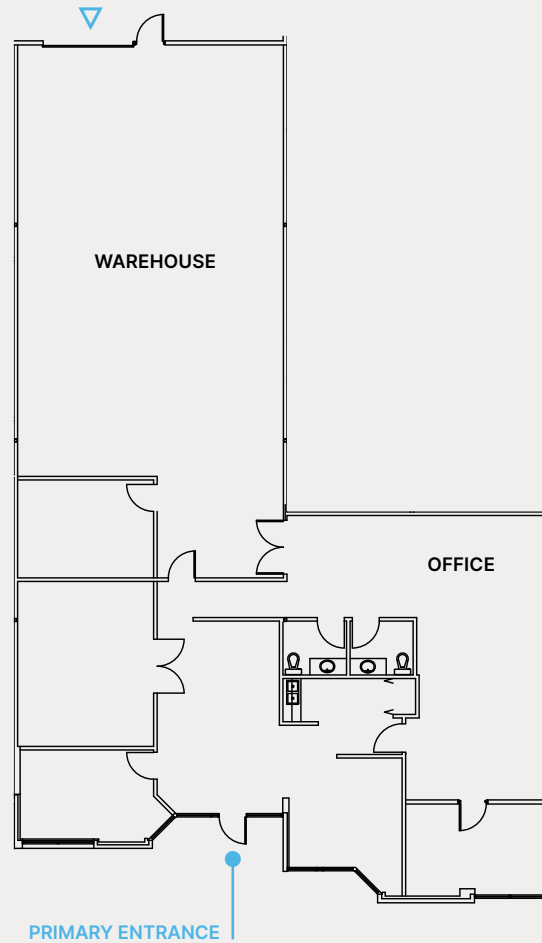

KEY PLANS

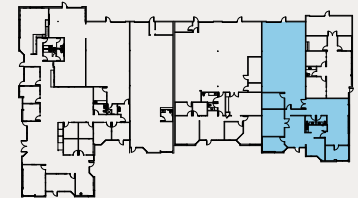

JASON BLOOM

425.450.1102 | jason.bloom@kidder.com | westparkredmond.com

DRAWING NOT TO SCALE

As-built subject to field verification

UPDATED 05.2026 | This information supplied herein is from sources we deem reliable. It is provided without any representation, warranty, or guarantee, expressed or implied as to its accuracy. Prospective Buyer or Tenant should conduct an independent investigation and verification of all matters deemed to be material, including, but not limited to, statements of income and expenses. Consult your attorney, accountant, or other professional advisor.

▲ GRADE LEVEL

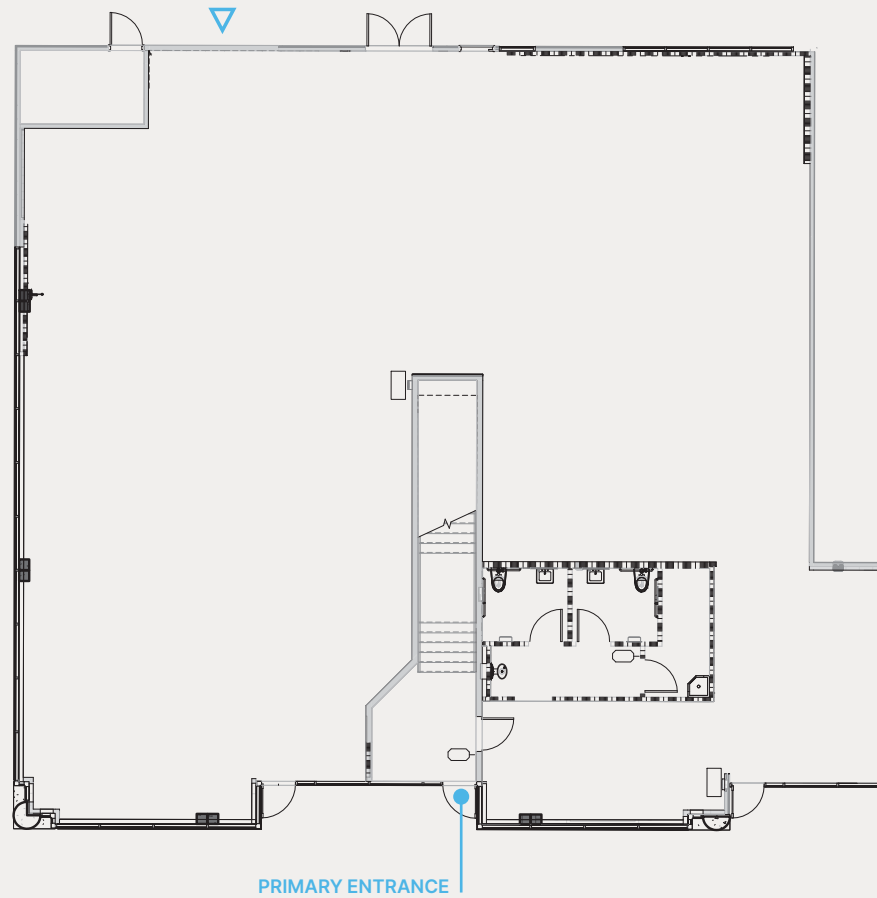

KEY PLANS

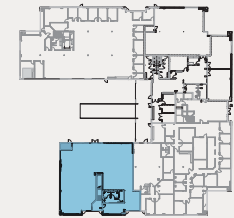

JASON BLOOM

425.450.1102 | jason.bloom@kidder.com | westparkredmond.com

DRAWING NOT TO SCALE

As-built subject to field verification

UPDATED 05.2026 | This information supplied herein is from sources we deem reliable. It is provided without any representation, warranty, or guarantee, expressed or implied as to its accuracy. Prospective Buyer or Tenant should conduct an independent investigation and verification of all matters deemed to be material, including, but not limited to, statements of income and expenses. Consult your attorney, accountant, or other professional advisor.

BUILD OUT NOTES:

R&D/Flex space with small warehouse,
grade-level loading, temp controlled R&D
area with polished concrete floors. Move-in
ready condition.

7,177 RSF OFFICE
353 RSF WAREHOUSE

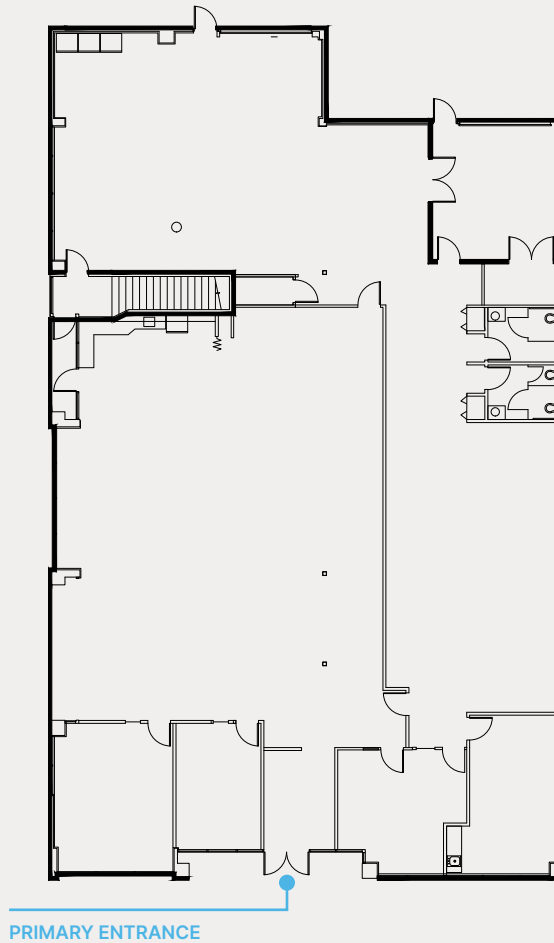

KEY PLANS

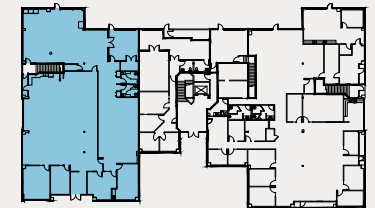

JASON BLOOM

425.450.1102 | jason.bloom@kidder.com | westparkredmond.com

DRAWING NOT TO SCALE

As-built subject to field verification

UPDATED 05.2026 | This information supplied herein is from sources we deem reliable. It is provided without any representation, warranty, or guarantee, expressed or implied as to its accuracy. Prospective Buyer or Tenant should conduct an independent investigation and verification of all matters deemed to be material, including, but not limited to, statements of income and expenses. Consult your attorney, accountant, or other professional advisor.

Westpark

BUILDING N

8620 154th Avenue NE
Redmond, WA

BUILD OUT NOTES:
Flex R&D space with dock & grade-level loading, high-end finishes, and move-in ready condition.

Suites
105/110
7,708 RSF

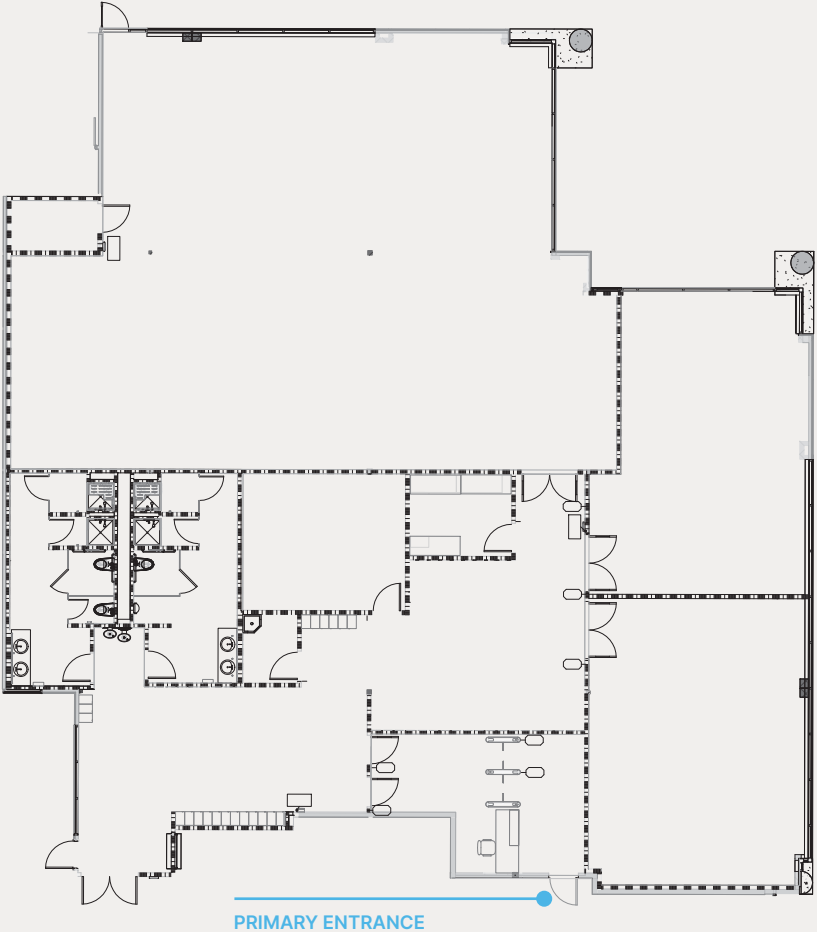

KEY PLANS

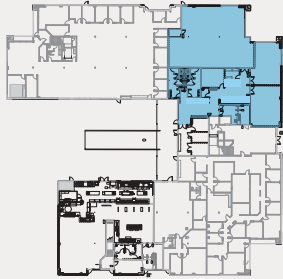

JASON BLOOM
425.450.1102 | jason.bloom@kidder.com | westparkredmond.com

DRAWING NOT TO SCALE
As-built subject to field verification

UPDATED 05.2026 | This information supplied herein is from sources we deem reliable. It is provided without any representation, warranty, or guarantee, expressed or implied as to its accuracy. Prospective Buyer or Tenant should conduct an independent investigation and verification of all matters deemed to be material, including, but not limited to, statements of income and expenses. Consult your attorney, accountant, or other professional advisor.



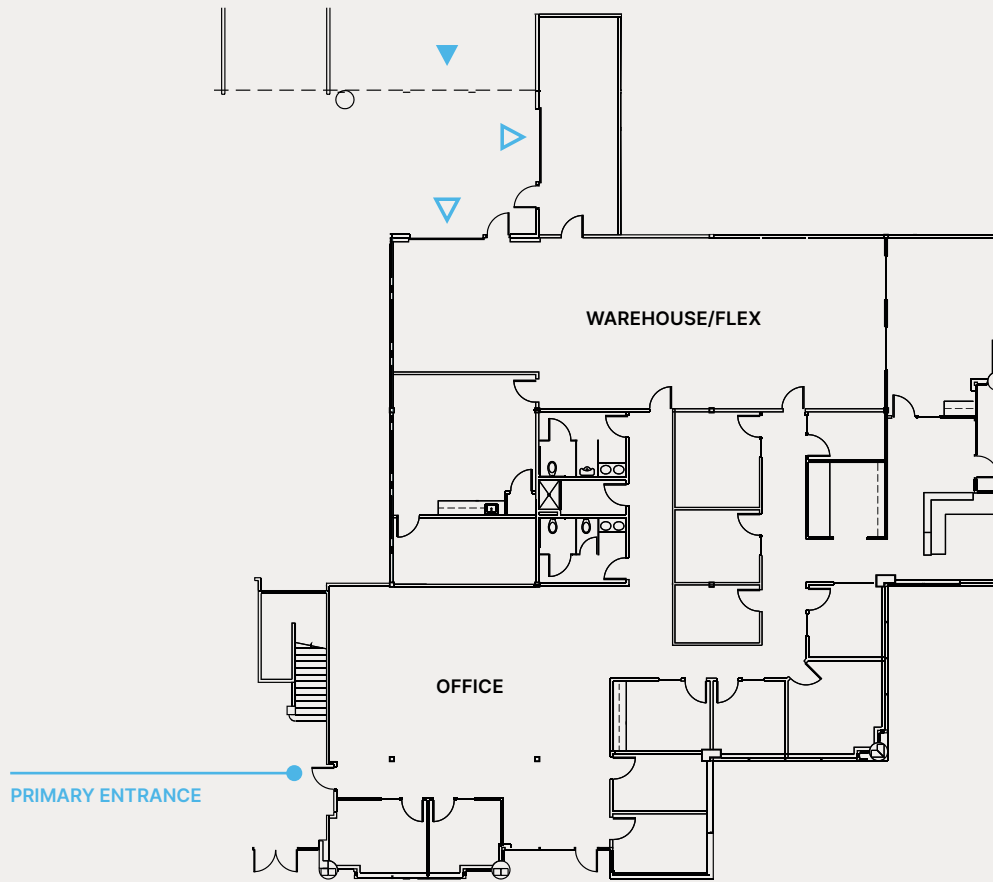

5,417 RSF OFFICE
2,339 RSF WAREHOUSE

- ▲ GRADE LEVEL
- ▲ DOCK HIGH

KEY PLANS

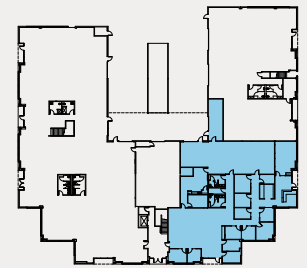

JASON BLOOM

425.450.1102 | jason.bloom@kidder.com | westparkredmond.com

DRAWING NOT TO SCALE

As-built subject to field verification

UPDATED 05.2026 | This information supplied herein is from sources we deem reliable. It is provided without any representation, warranty, or guarantee, expressed or implied as to its accuracy. Prospective Buyer or Tenant should conduct an independent investigation and verification of all matters deemed to be material, including, but not limited to, statements of income and expenses. Consult your attorney, accountant, or other professional advisor.

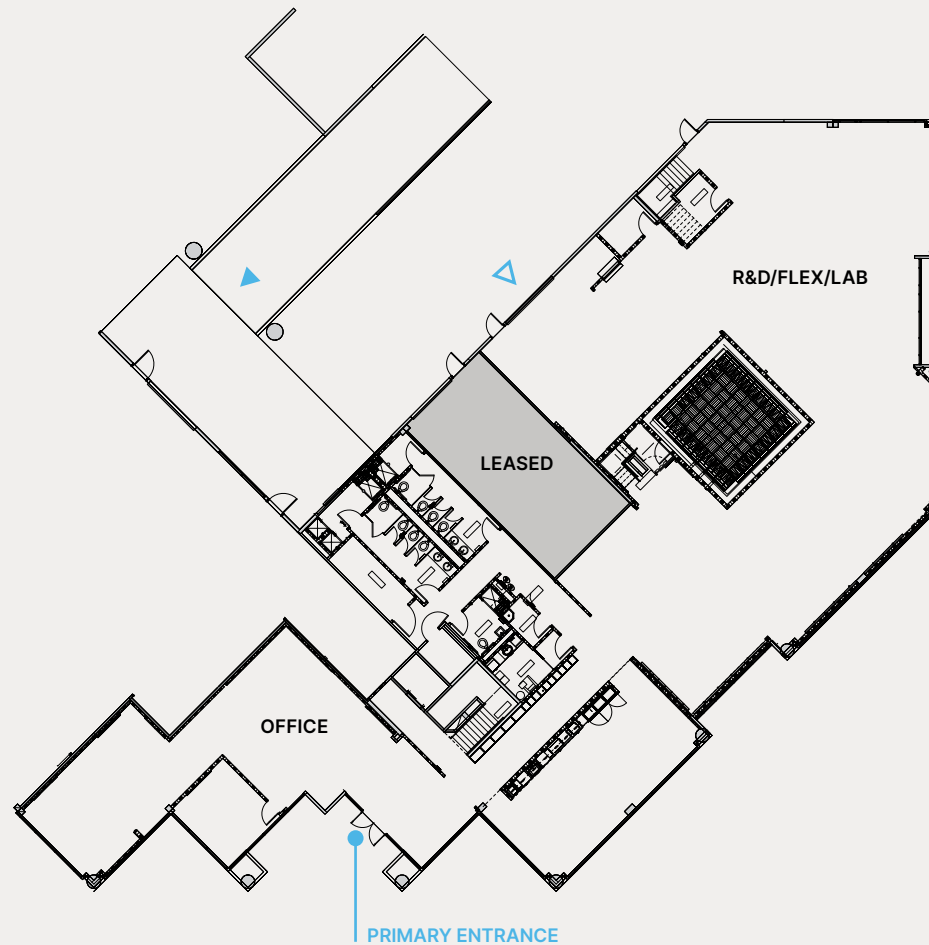

△ GRADE LEVEL
▲ DOCK HIGH

KEY PLANS



JASON BLOOM

425.450.1102 | jason.bloom@kidder.com | westparkredmond.com

DRAWING NOT TO SCALE

As-built subject to field verification

UPDATED 05.2026 | This information supplied herein is from sources we deem reliable. It is provided without any representation, warranty, or guarantee, expressed or implied as to its accuracy. Prospective Buyer or Tenant should conduct an independent investigation and verification of all matters deemed to be material, including, but not limited to, statements of income and expenses. Consult your attorney, accountant, or other professional advisor.

Westpark

BUILDING M

8510 154th Avenue NE
Redmond, WA

BUILD OUT NOTES:
Office/Lab on second floor, incredible
finishes, furniture available.

Suite 200
21,727 RSF

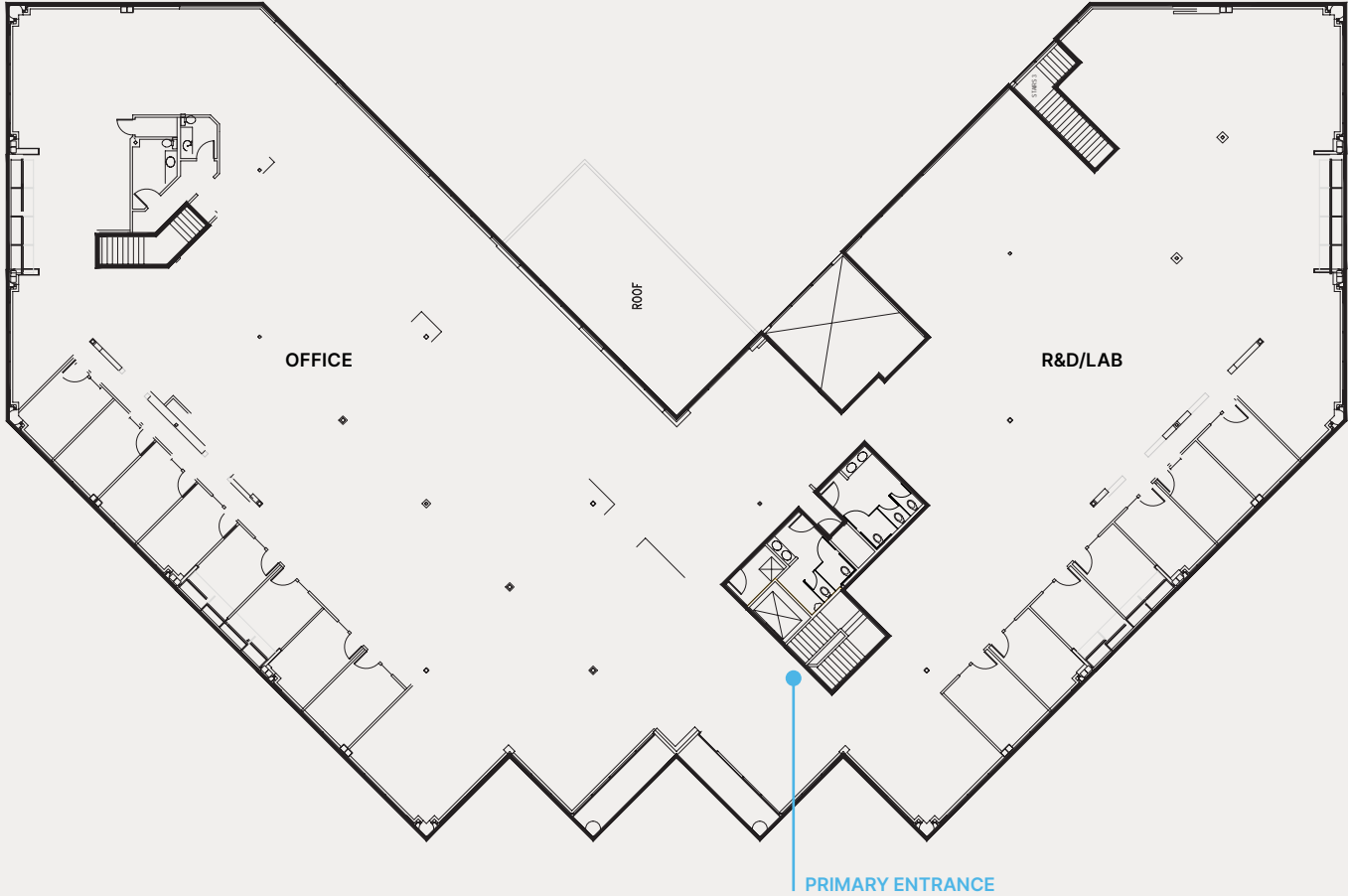

JASON BLOOM

425.450.1102 | jason.bloom@kidder.com | westparkredmond.com

DRAWING NOT TO SCALE

As-built subject to field verification

UPDATED 05.2026 | This information supplied herein is from sources we deem reliable. It is provided without any representation, warranty, or guarantee, expressed or implied as to its accuracy. Prospective Buyer or Tenant should conduct an independent investigation and verification of all matters deemed to be material, including, but not limited to, statements of income and expenses. Consult your attorney, accountant, or other professional advisor.



Westpark

BUILDING A

8210 154th Avenue NE
Redmond, WA

BUILD OUT NOTES:
Rare production, R&D and warehousing space. Dock- and grade-level loading, 24' clear height, heavy power, flex layout.

Suites
100/230
32,412 RSF

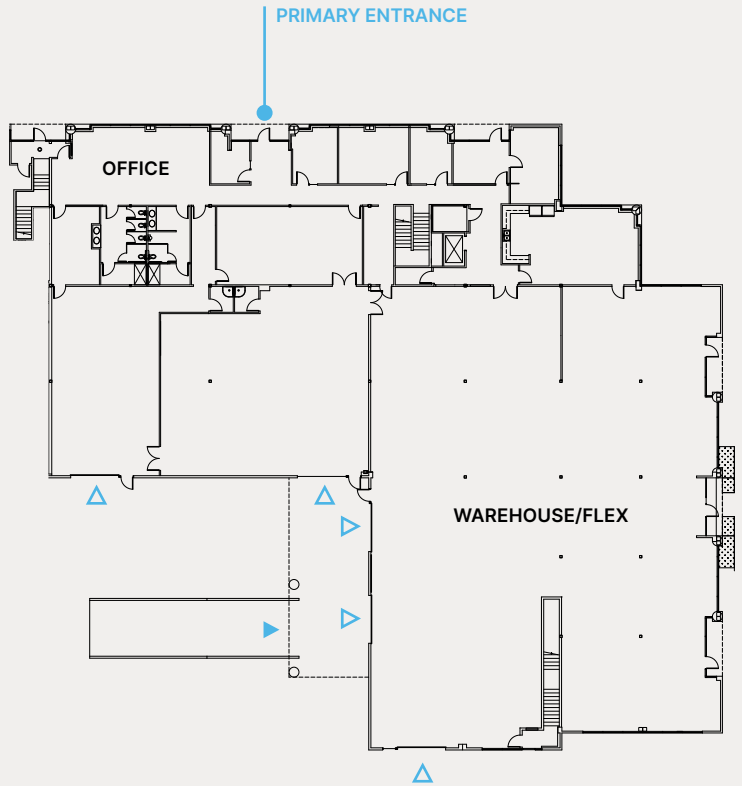

1ST FLOOR | SUITE 100

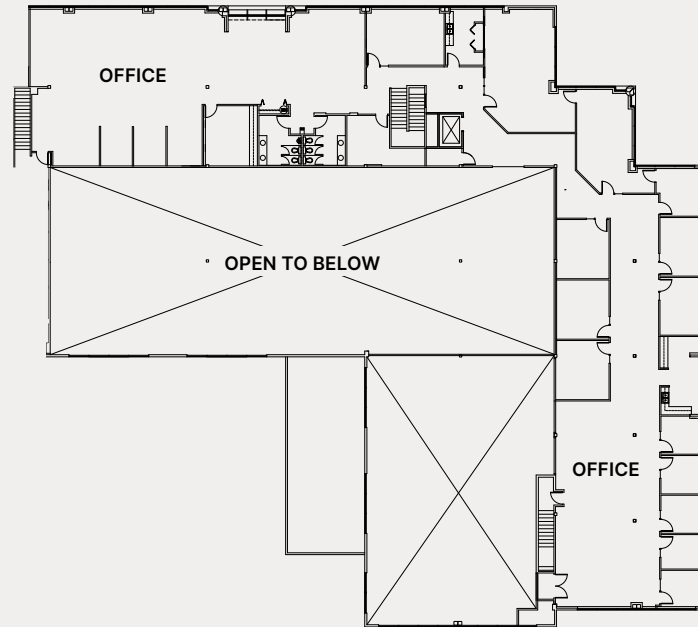

2ND FLOOR | SUITE 230

16,922 RSF OFFICE
15,490 RSF WAREHOUSE
▲ GRADE LEVEL
▲ DOCK HIGH

KEY PLANS

1ST FLOOR

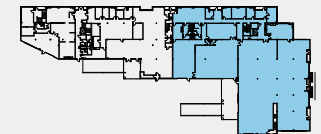

2ND FLOOR

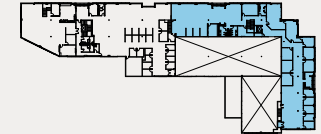

JASON BLOOM

425.450.1102 | jason.bloom@kidder.com | westparkredmond.com

DRAWING NOT TO SCALE

As-built subject to field verification

UPDATED 05.2026 | This information supplied herein is from sources we deem reliable. It is provided without any representation, warranty, or guarantee, expressed or implied as to its accuracy. Prospective Buyer or Tenant should conduct an independent investigation and verification of all matters deemed to be material, including, but not limited to, statements of income and expenses. Consult your attorney, accountant, or other professional advisor.



Westpark

BUILDING C

8410 154th Avenue NE
Redmond, WA

BUILD OUT NOTES:

Rare stand-alone buildings with high-end finishes, read to configure to tenant's needs. Existing mix of open-to-ceiling office finishes, R&D/Lab space, and warehouse space with dock- and grade-level loading.

Full Building
56,264 RSF

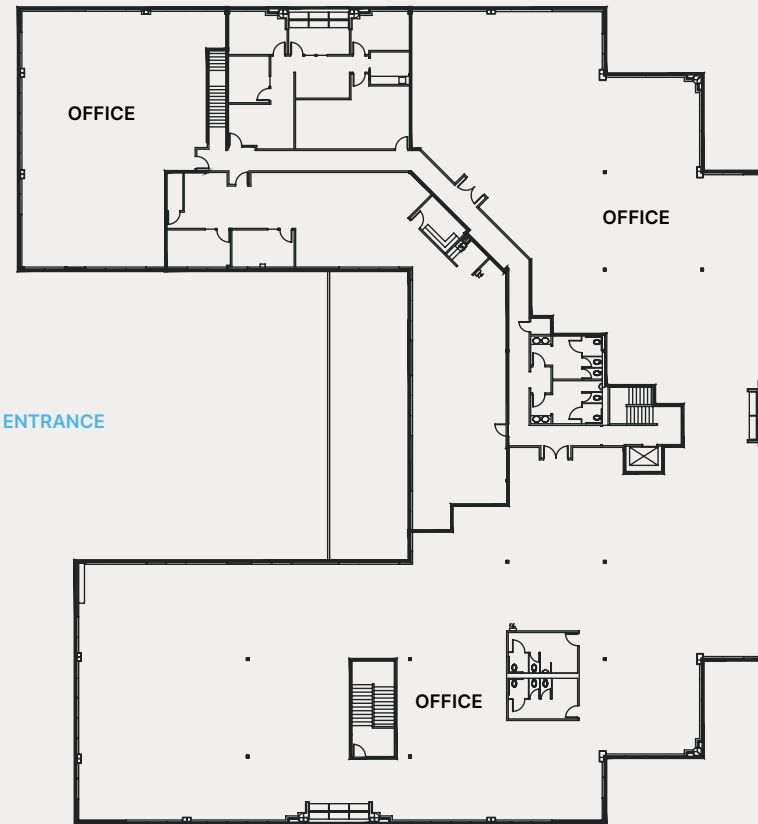
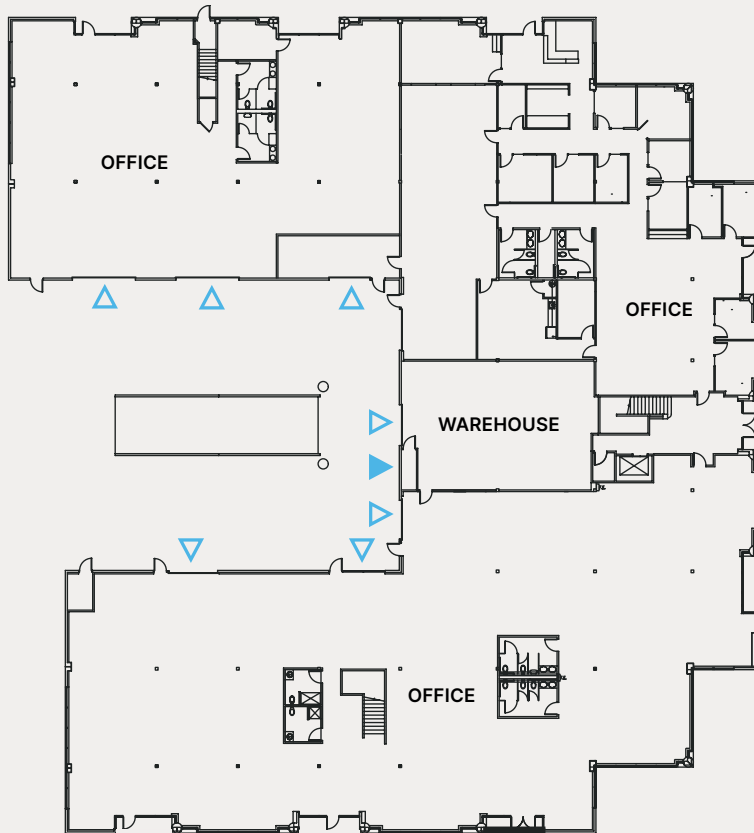

▲ GRADE LEVEL
▲ DOCK HIGH

1ST FLOOR

2ND FLOOR | SUITE 230

JASON BLOOM

425.450.1102 | jason.bloom@kidder.com | westparkredmond.com

DRAWING NOT TO SCALE

As-built subject to field verification

UPDATED 05.2026 | This information supplied herein is from sources we deem reliable. It is provided without any representation, warranty, or guarantee, expressed or implied as to its accuracy. Prospective Buyer or Tenant should conduct an independent investigation and verification of all matters deemed to be material, including, but not limited to, statements of income and expenses. Consult your attorney, accountant, or other professional advisor.

